

POTONGAN A-A KAWASAN
 Skala 1:300

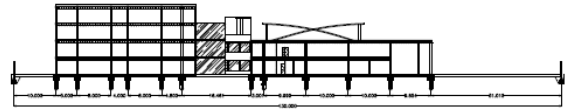

POTONGAN B-B KAWASAN
 Skala 1:300

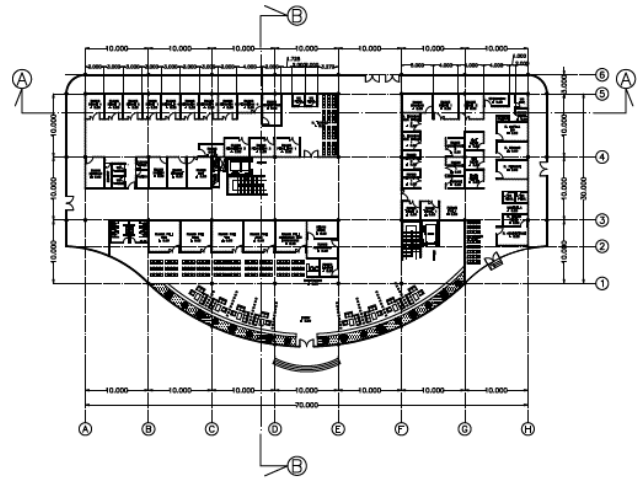
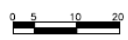

DENAH L1 MASSA 1
 Skala 1:200

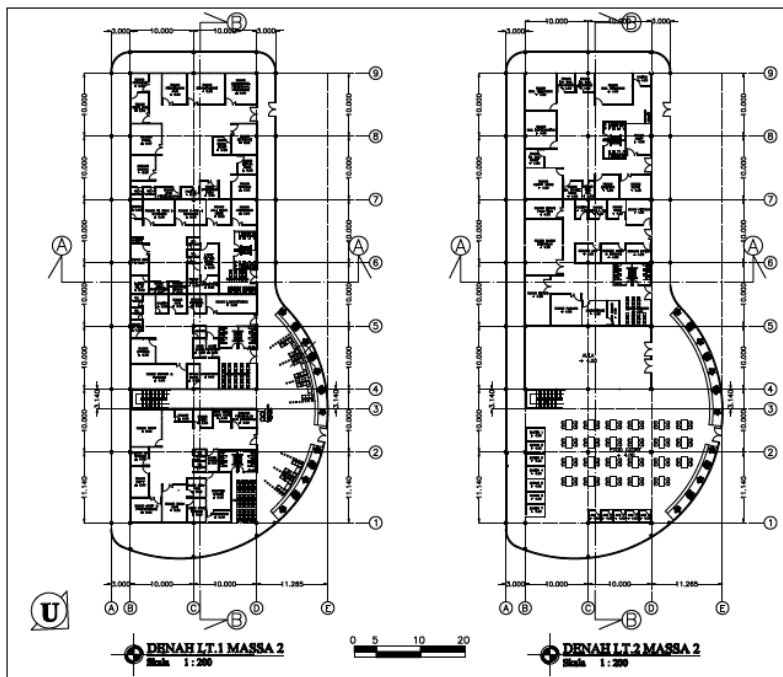
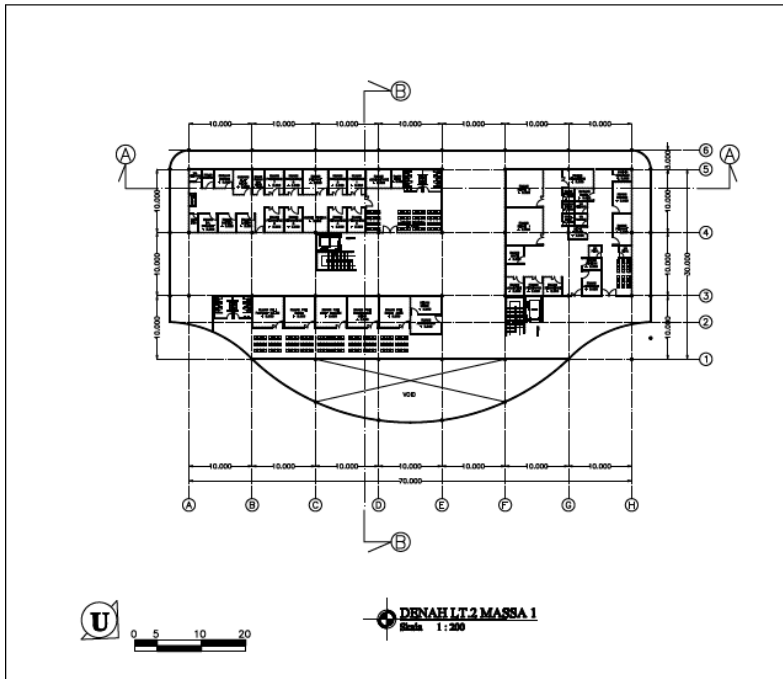

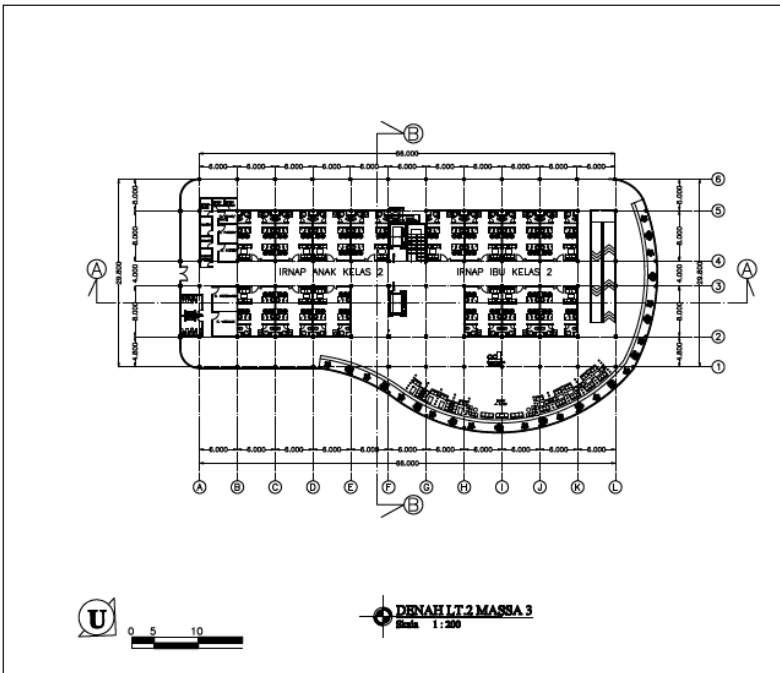
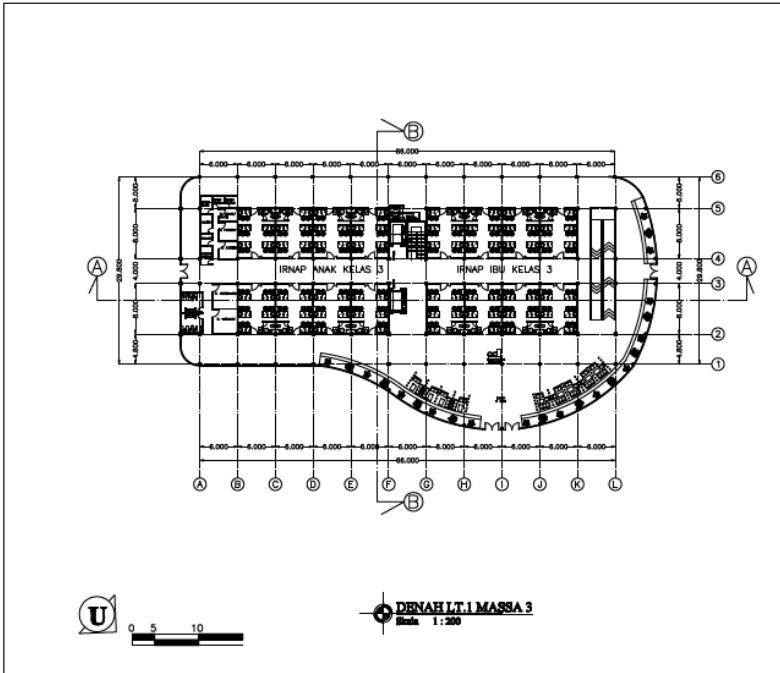

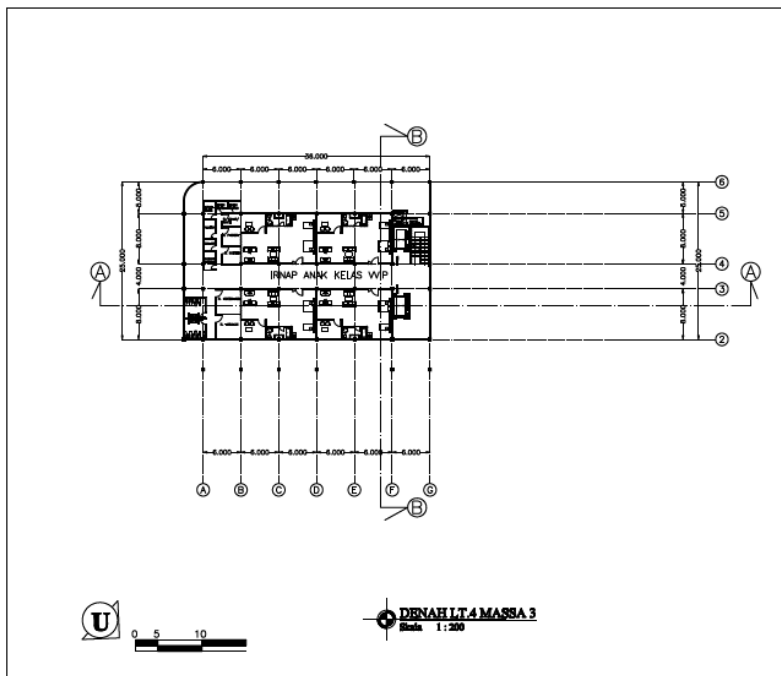
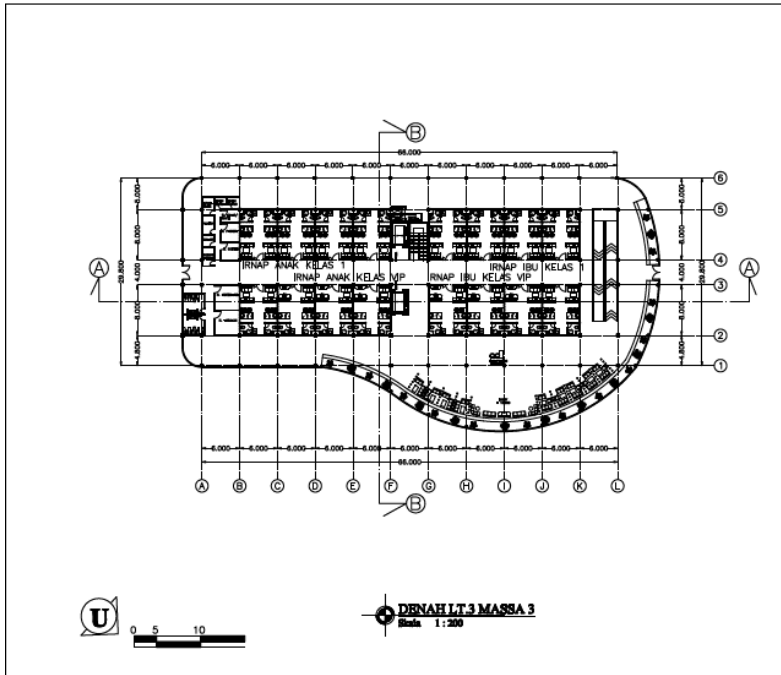

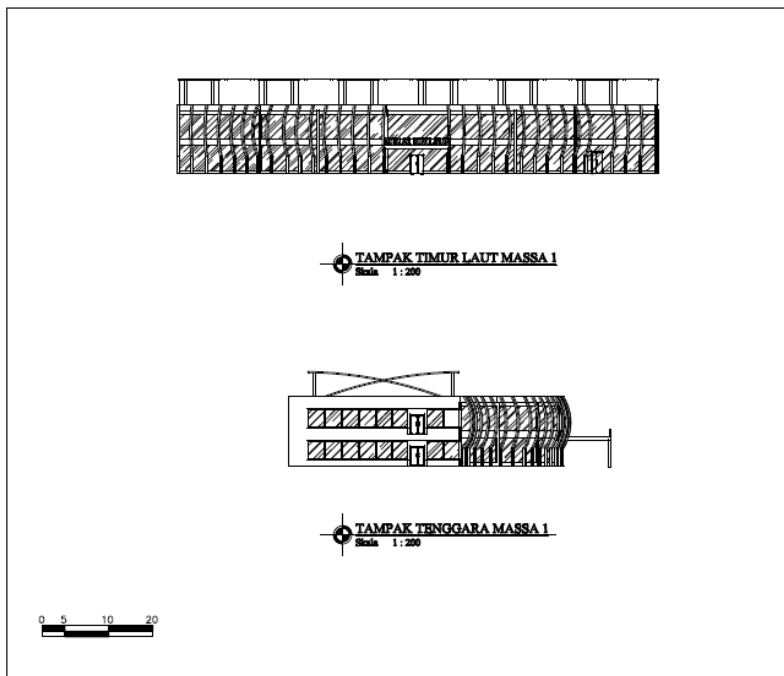
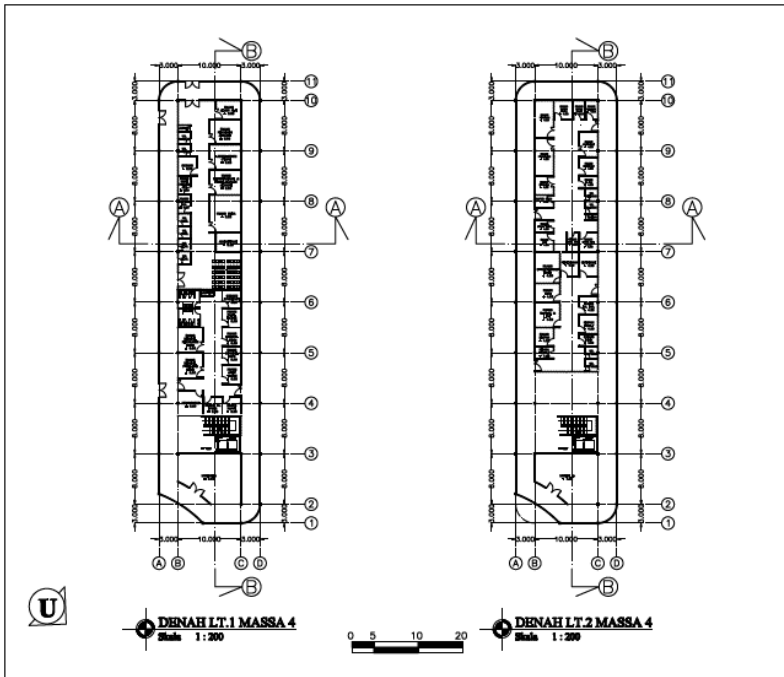

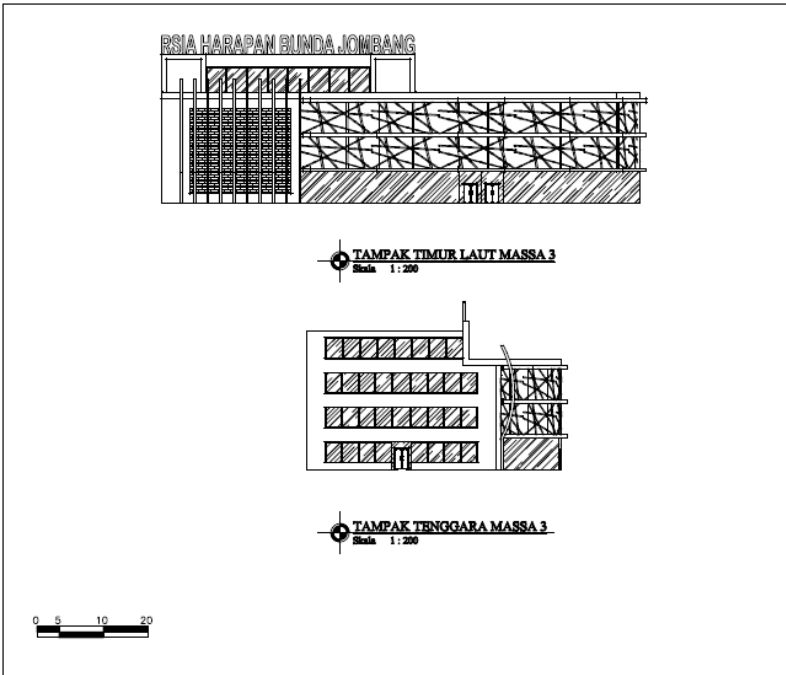
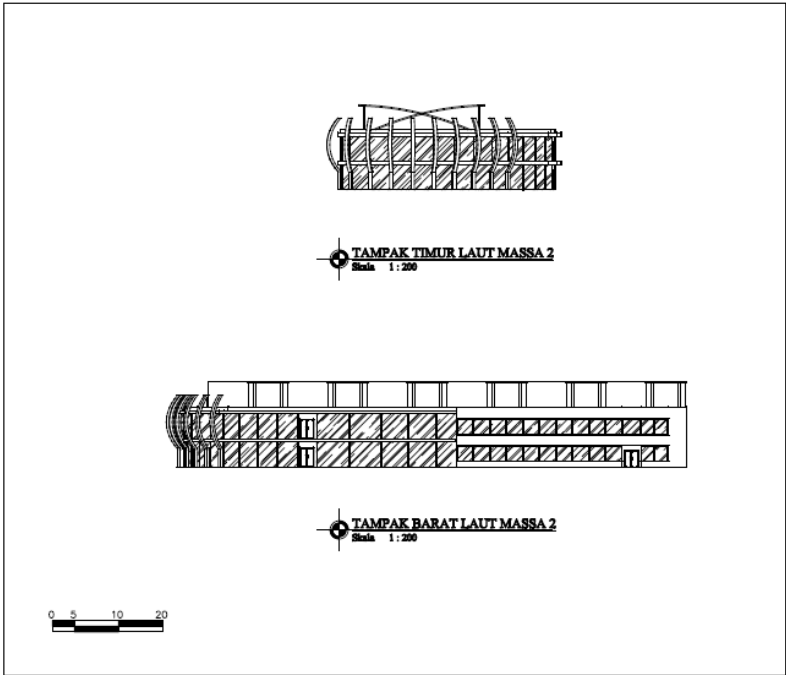

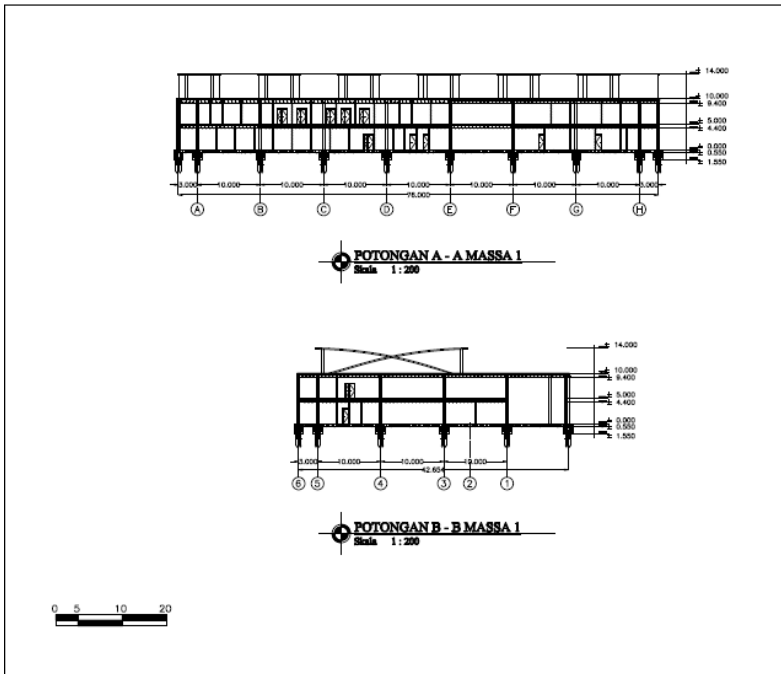
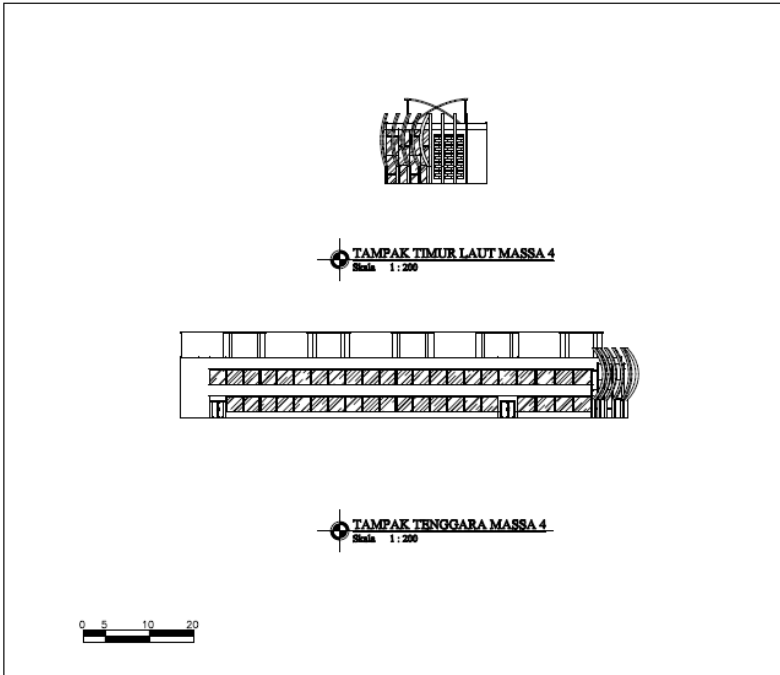

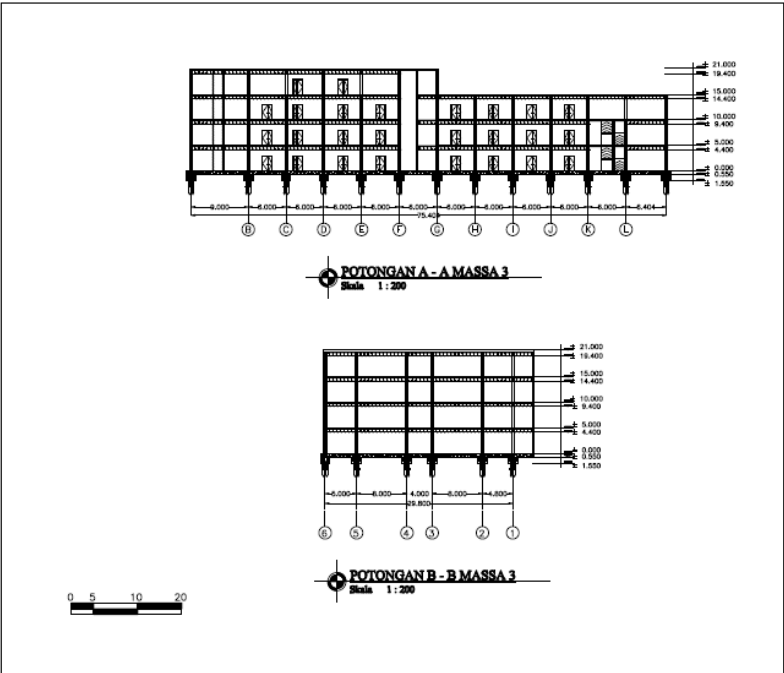
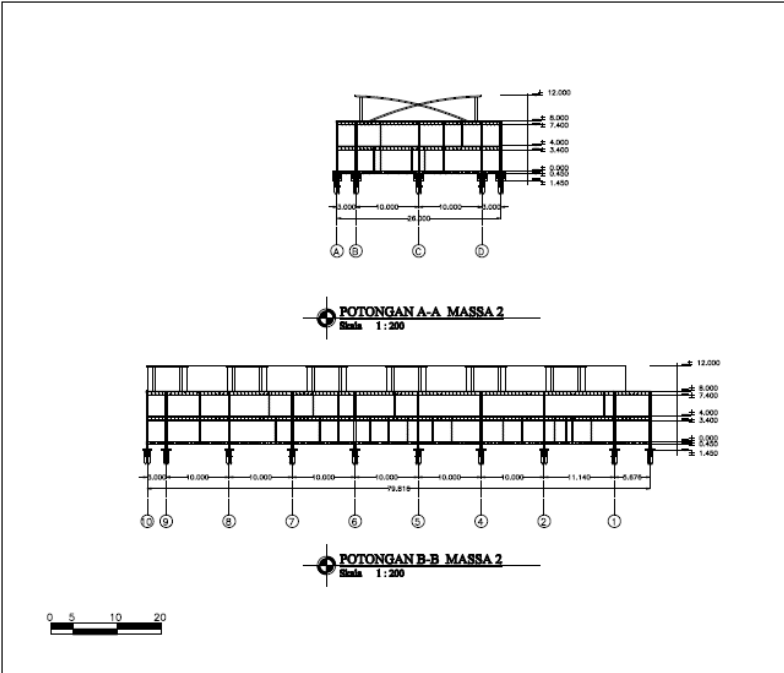

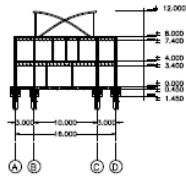

POTONGAN A-A MASSA 4
 Skala 1:200

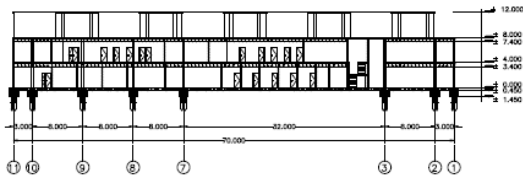

POTONGAN B-B MASSA 4
 Skala 1:200

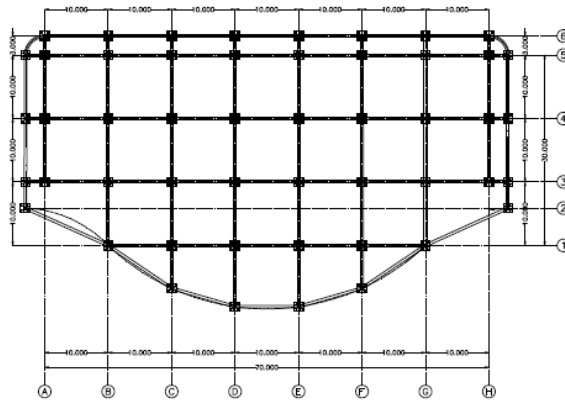

DENAH RENC. FONDASI MASSA 1
 Skala 1:200

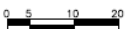

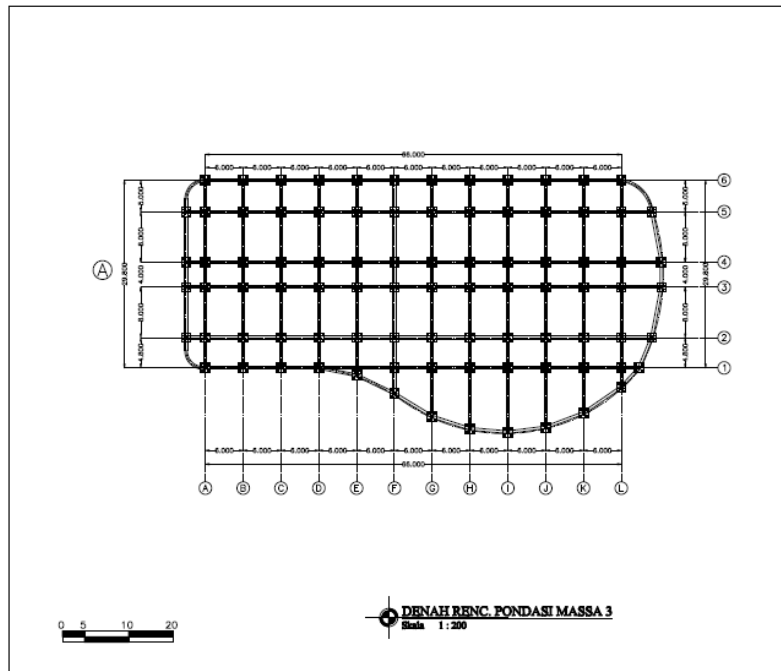
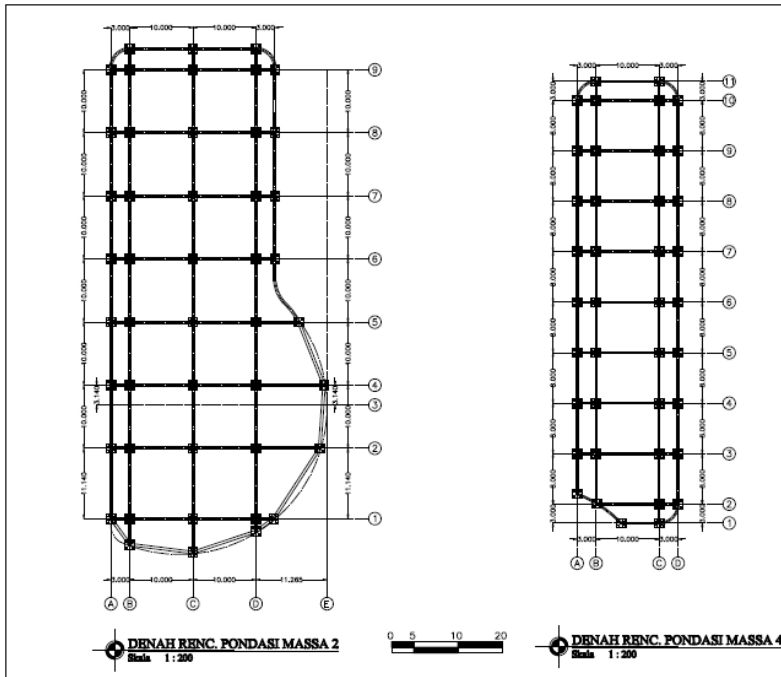

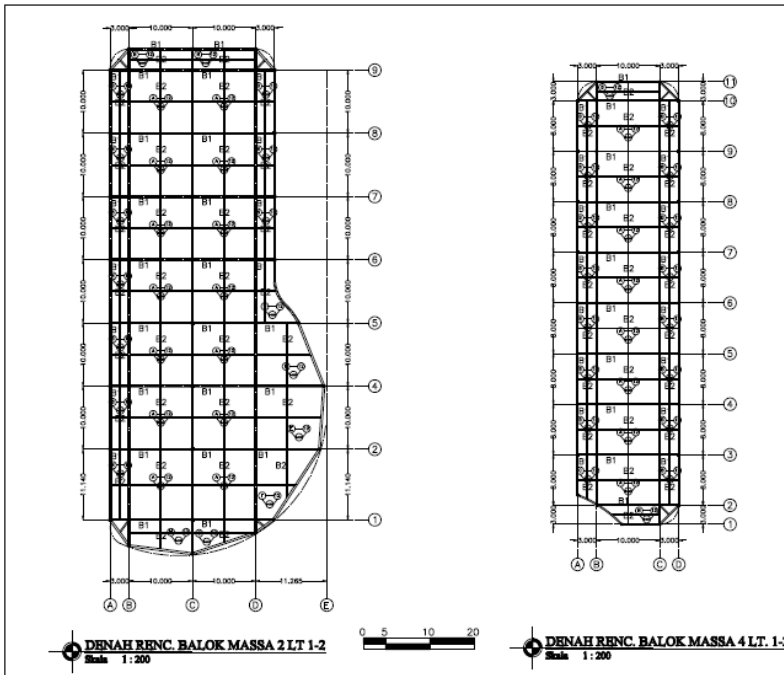
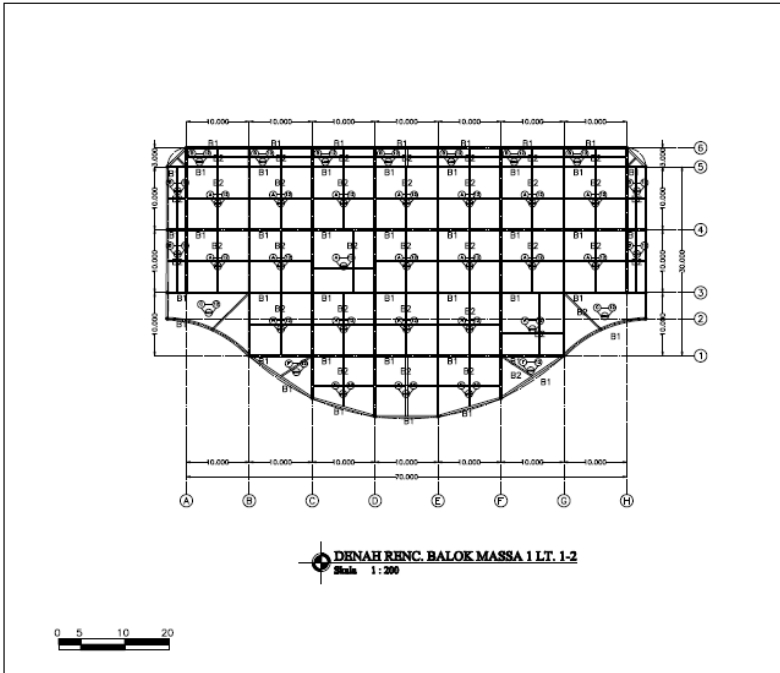

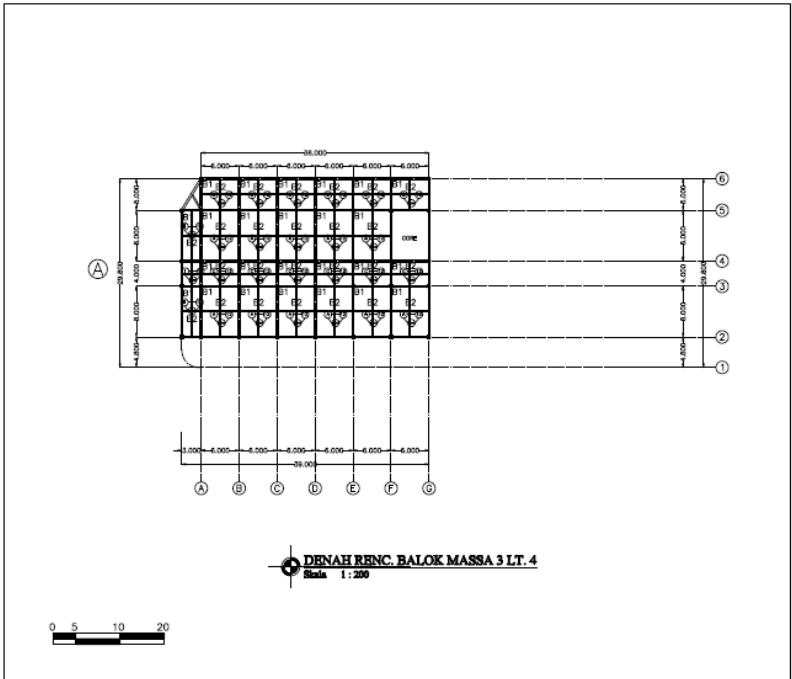
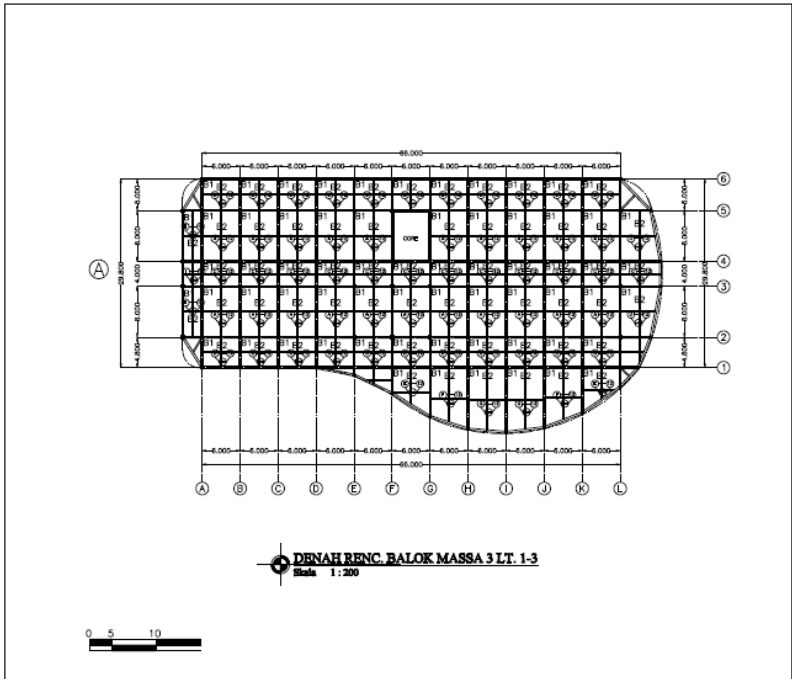

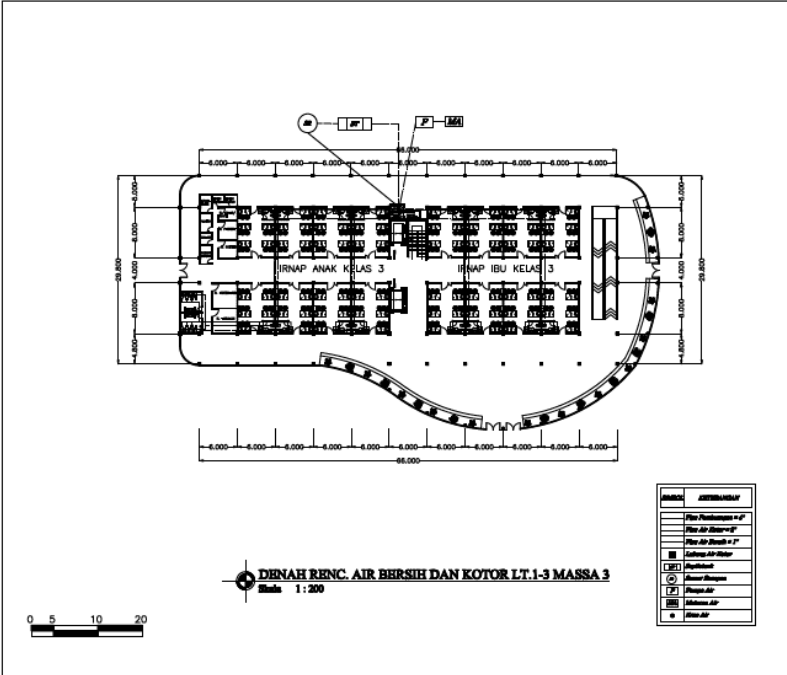
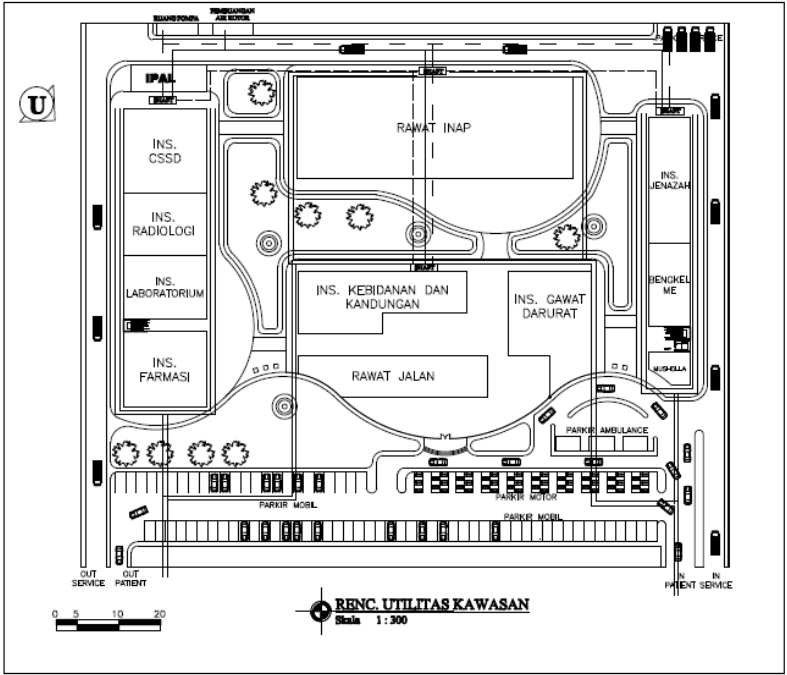

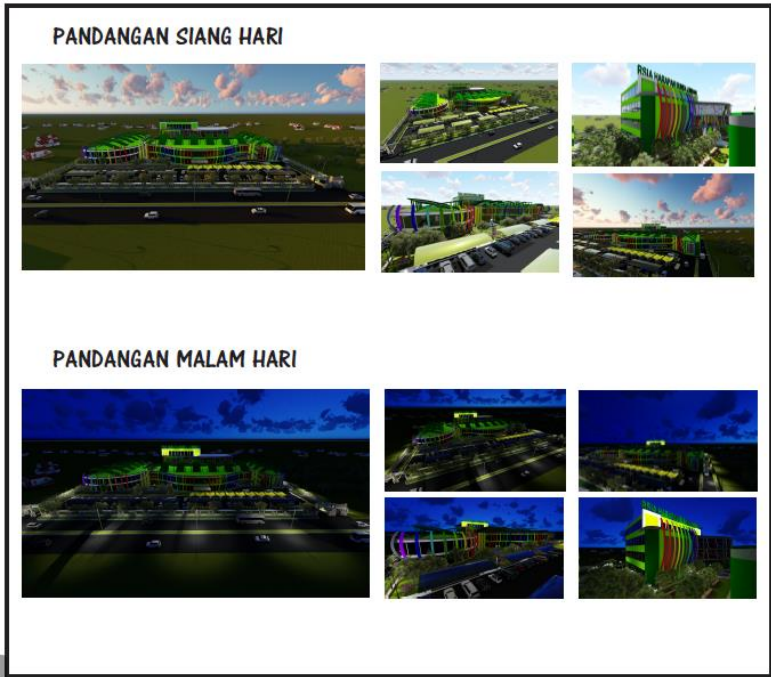
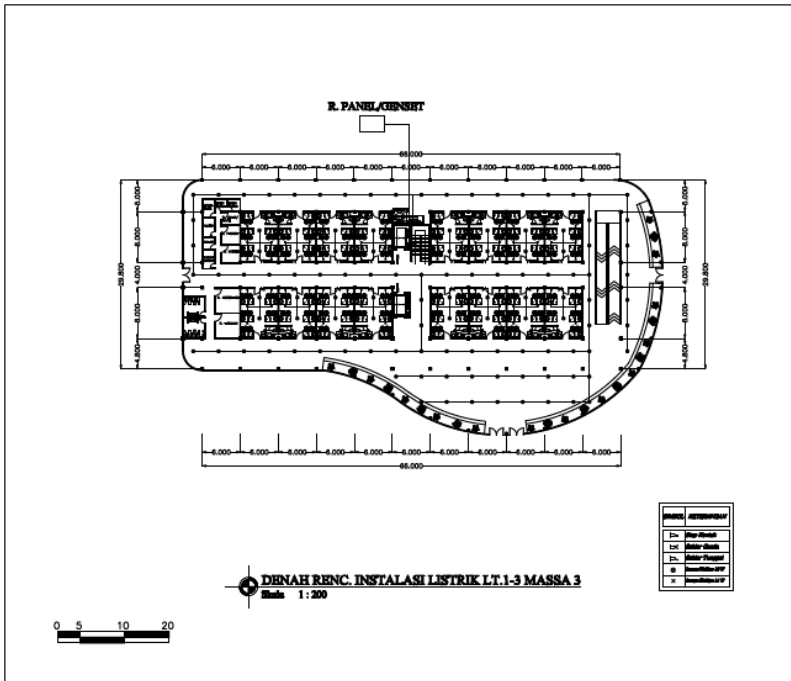

INTERIOR



INTERIOR LOBBY UTAMA



INTERIOR KAMAR KELAS 3



INTERIOR KAMAR VVIP CLASS