

# LAMPIRAN

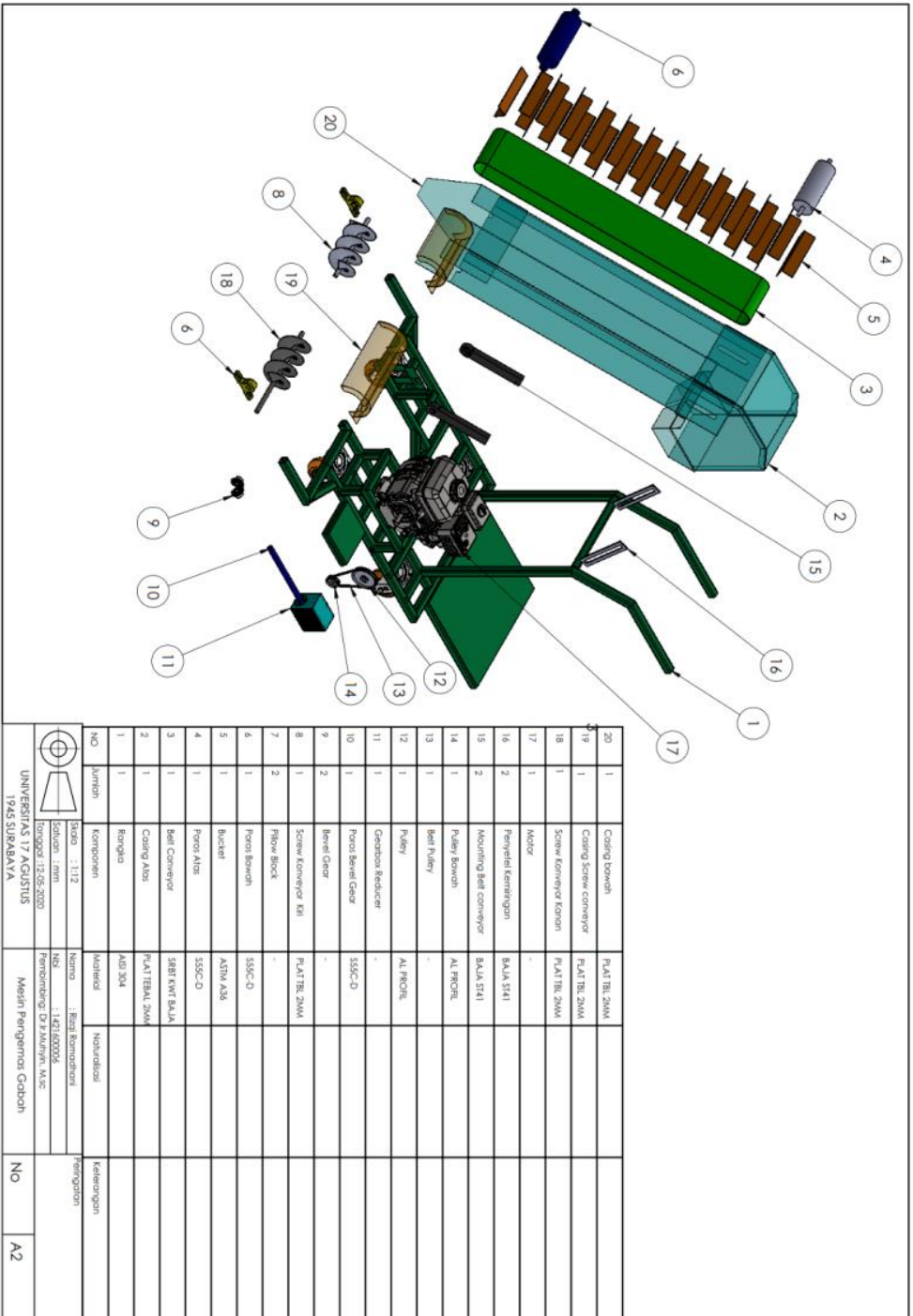

20	1	Coring Bowohn	PLATIR, 2MM		
19	1	Coring Screw conveyor	PLATIR, 2MM		
18	1	Screw conveyor konon	PLATIR, 2MM		
17	1	Motor	-		
16	2	Pemvelat kermangan	BAJA ST41		
15	2	Mounting belt conveyor	BAJA ST41		
14	1	Pulley Bowohn	AL PROTEL		
13	1	Belt Pulley	-		
12	1	Pulley	AL PROTEL		
11	1	Gendbox Reducer	-		
10	1	Pivot Bevel Gear	SS5C-D		
9	2	Bevel Gear	-		
8	1	Screw conveyor BBI	PLATIR, 2MM		
7	2	Fillow Block	-		
6	1	Pivot Bowohn	SS5C-D		
5	1	Bucket	ASTM A36		
4	1	Pivot Axis	SS5C-D		
3	1	Belt Conveyor	SREI RWIT BAJA		
2	1	Coring Axis	PLATIRAL, 2MM		
1	1	Bangka	AD35M		
NO	Jumlah	Komponen	Materi	Nominal	Keterangan
		Skala : 1:12	Nama : Eka Romadhoni		
		Solusi : mm	NSN : 1421400004		
		Tanggal : 12.05.2020	Pembimbing : DPA Mulya, M.Sc		
		UNIVERSITAS 17 AGUSTUS 1945 SURABAYA	Mesin Pengemas Guboh		
					NO A2

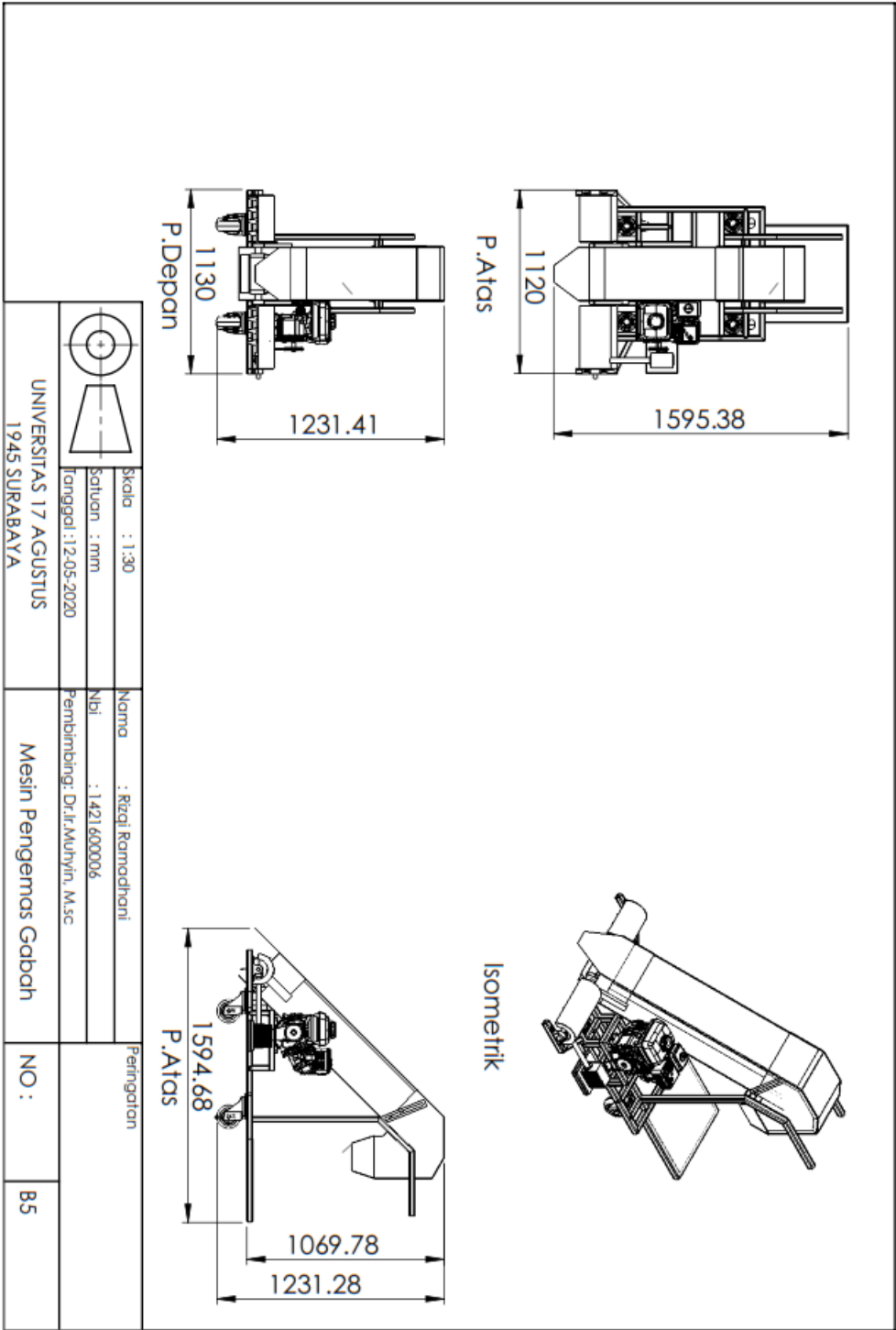

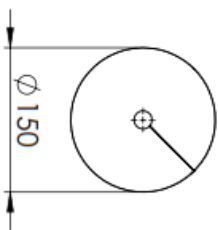
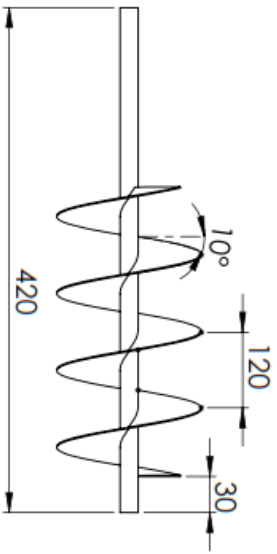
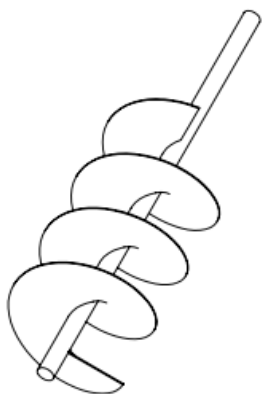
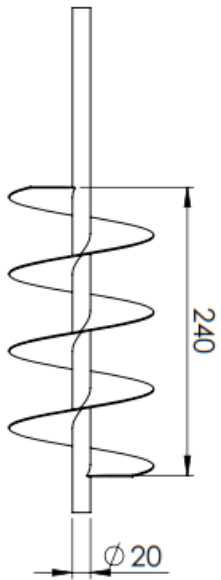

Skala : 1:5	Nama : Rizqi Ramadhani
Solusun : mm	Nbi : 1421600006
Tanggal : 12-05-2020	Pembimbing: Dr.Ir. Muhyin, M.sc

Peringatan

UNIVERSITAS 17 AGUSTUS  
1945 SURABAYA

SCREW CONVEYOR KIRI

NO :

85



P. Atas

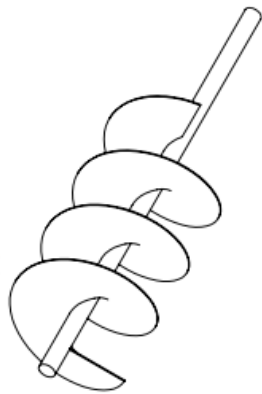

Isometric

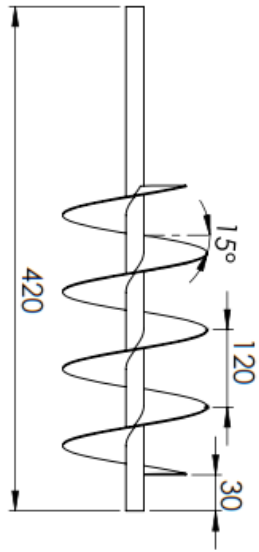

P. Depan

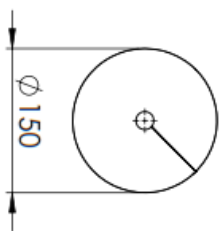

P. Samping

	Skala : 1:5	Nama : Rizqi Ramadhani	Peringatan	
	Satuan : mm	NIdi : 1421600006		
	Tanggal : 12-05-2020	Pembimbing: Dr./r. Mulyati, M.Sc		
UNIVERSITAS 17 AGUSTUS 1945 SURABAYA		SCREW CONVEYOR KIRI	NO :	BS

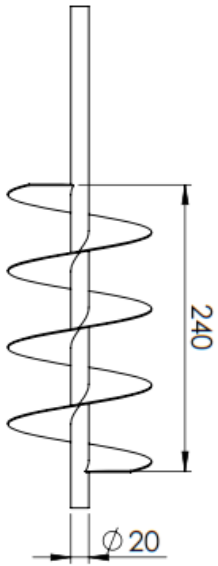

P. Atas

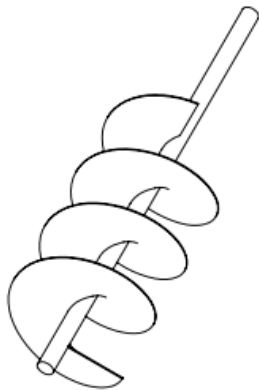

Isometric

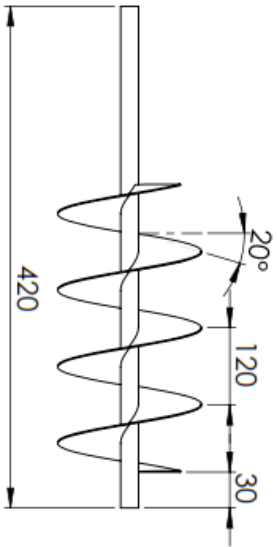

P. Depan

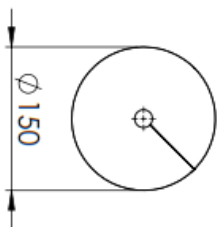

P. Sampling

	Skala : 1:5	Nama : Rizqi Ramadhani	Peringatan	
	Satuan : mm	Nbi : 1421600006		
	Tanggal : 12-05-2020	Pembimbing: Dr.Ir. Muhyin, M.Sc		
UNIVERSITAS 17 AGUSTUS 1945 SURABAYA		SCREW CONVEYOR KIRI	NO :	B5

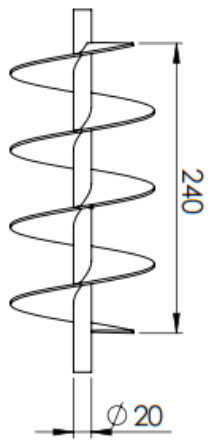

P. Atas

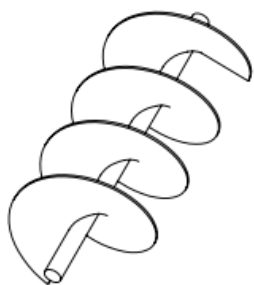

Isometric

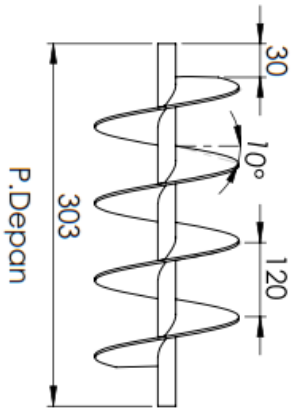

P. Depan

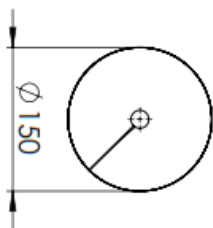

P. Samping

	Skala : 1:5	Nama : Rizqi Ramadhani	Peringatan
	Selusin : mm	Nlbi : 1421600006	
Tanggal : 12-05-2020 Pembimbing: Dr. Ir. Muhyin, M.Sc		No. : 85	
UNIVERSITAS 17 AGUSTUS 1945 SURABAYA		SCREW CONVEYOR KANAN	

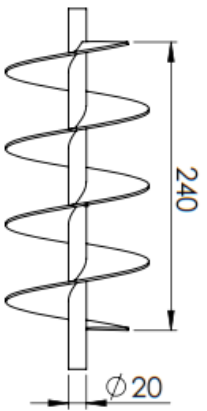

P. Atas

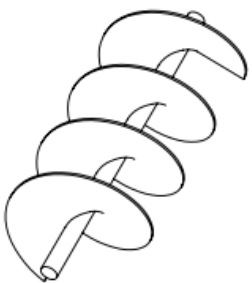

Isometric

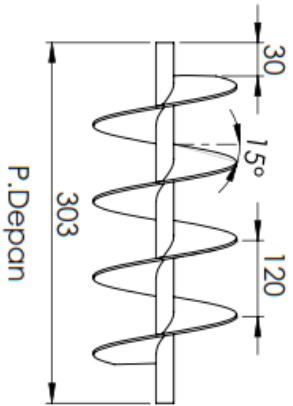

P. Depan

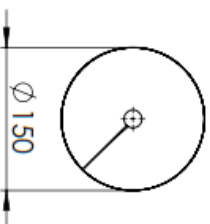

P. Samping

	Skala : 1:5	Nama : Rizqi Ramadhani	Peringatan
	Satuan : mm	NIP : 1421600006	
Tanggal : 12-05-2020		Pembimbing: Dr./r. Mulyati, M.Sc	
UNIVERSITAS 17 AGUSTUS 1945 SURABAYA		SCREW CONVEYOR KANAN	NO : B5

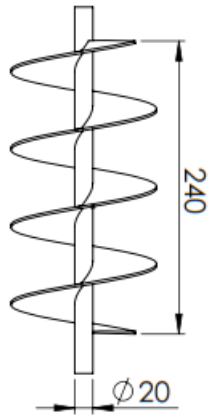

P. Atas

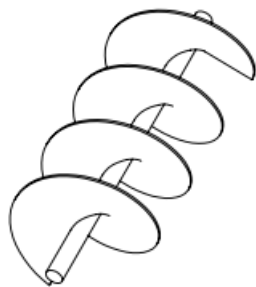

Isometric

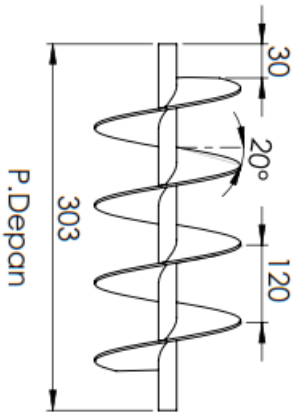

P. Depan

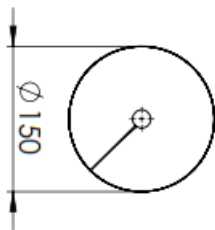

P. Samping

	Skala : 1:5	Nama : Rizqi Ramadhani	Peringatan
	Satuan : mm	Nbi : 1421600006	
Tanggal : 12.05.2020		Pembimbing: Dr.Ir.Muhyin, M.Sc	
UNIVERSITAS 17 AGUSTUS 1945 SURABAYA		SCREW CONVEYOR KIRI	
NO :		NO :	BS