

# LAMPIRAN

20	1	Coring Bottom	PLAT TEBL 2MM		
19	1	Coring Screw conveyor	PLAT TEBL 2MM		
18	1	Screw Conveyor Korong	PLAT TEBL 2MM		
17	1	Motor	-		
16	2	Pengstel Lembaran	BAJA S141		
15	2	Mounting Belt conveyor	BAJA S141		
14	1	Pulley Bawah	AL PROCEL		
13	1	Belt Pulley	-		
12	1	Pulley	AL PROCEL		
11	1	Gedbox Reducer	-		
10	1	Porsi Bawah Gear	SS304		
9	2	Beral Gear	-		
8	1	Screw Conveyor Kiri	PLAT TEBL 2MM		
7	2	Fluy Bawah	-		
6	1	Porsi Bawah	SS304		
5	1	Bucket	ASTM A36		
4	1	Porsi Atas	SS304		
3	1	Belt Conveyor	SEBUT KONT BAJA		
2	1	Coring Atas	PLAT TEBL 2MM		
1	1	Korong	MS304		

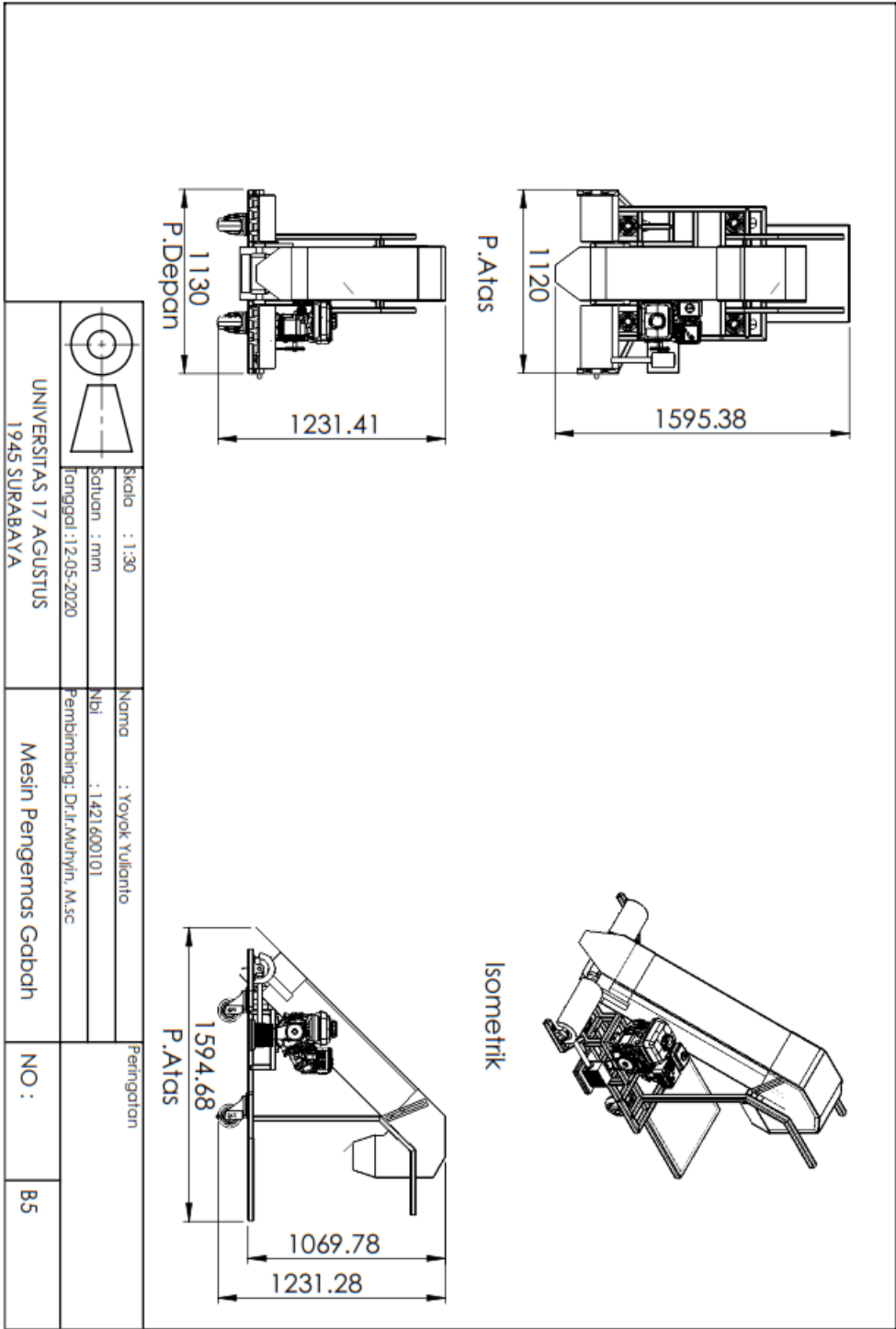

NO	Jumlah	Komponen	Materi	Nota/basis	Keterangan
		Skala : 1:12	Norma : Yogyakarta		
		Skala : mm	NSI : 1421 (60101)		
		Indogral : 12-05-2020	Pembimbing: Drg Alwyn, MSc		
UNIVERSITAS 17 AGUSTUS 1748 SURABAYA				Mesin Pengantar Gabah	NO
					A2



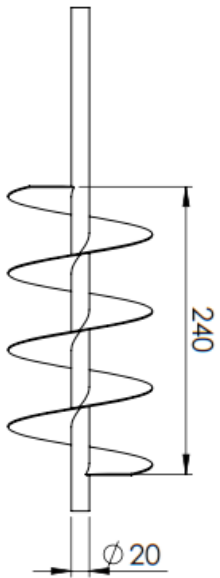

P. Atas

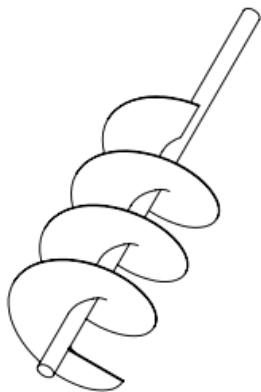

Isometric

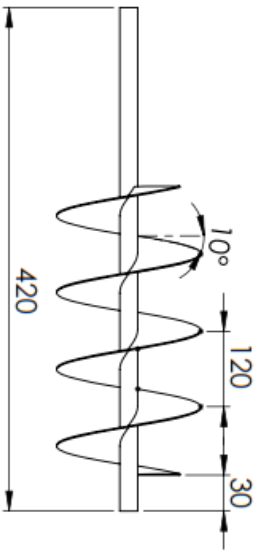

P. Depan

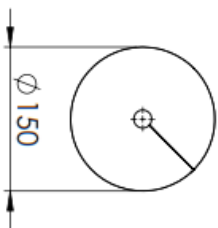

P. Samping

	Skala : 1:5	Nama :	Yoyok Yulianto	Peringatan
	Satuan : mm	Nbl :	1421600101	
UNIVERSITAS 17 AGUSTUS 1945 SURABAYA		Pembimbing: Dr.Ir.Muhyin, M.sc		NO :
SCREW CONVEYOR KIRI				BS

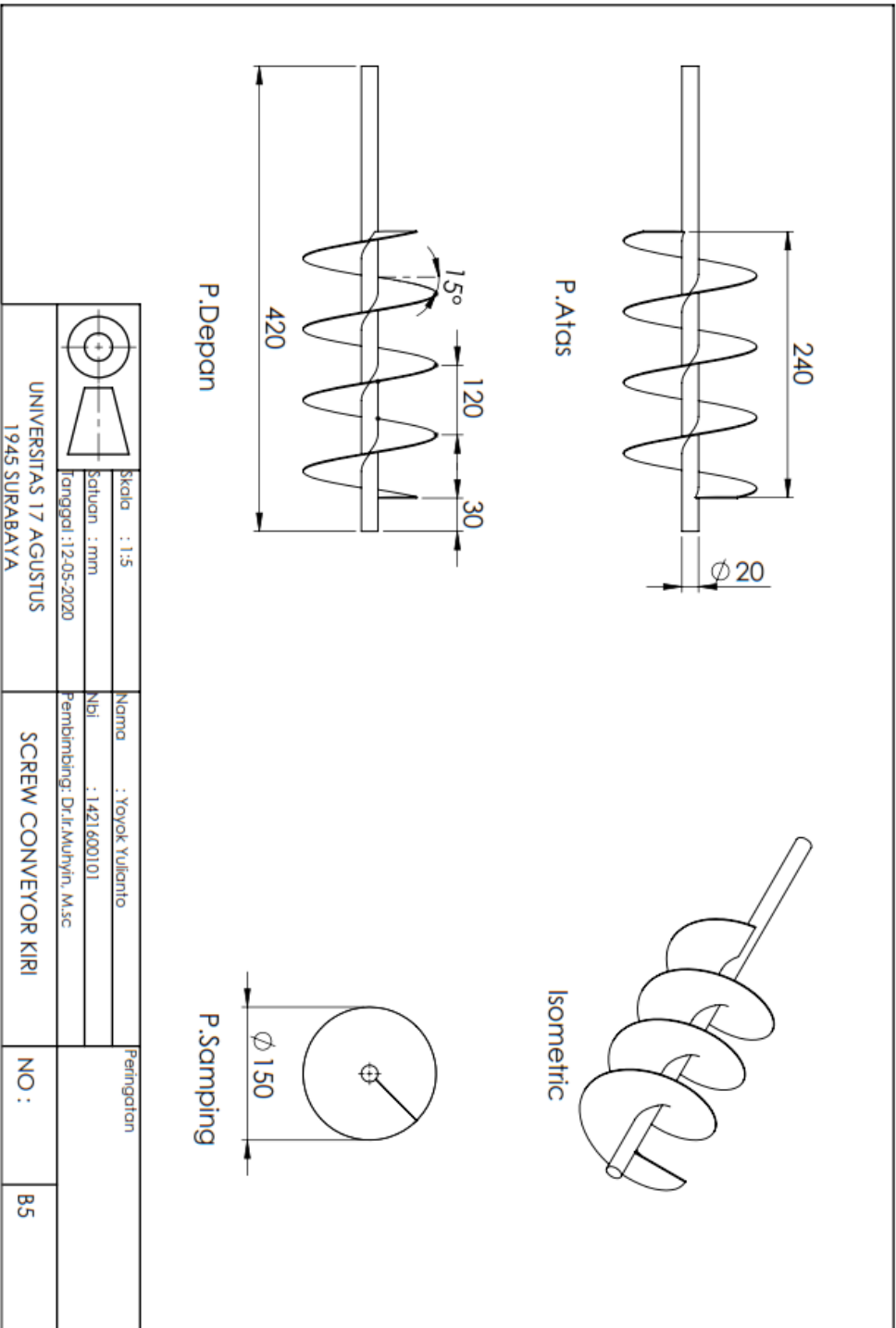

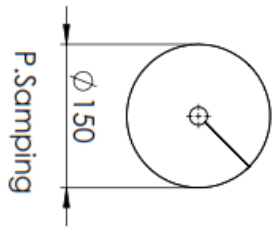
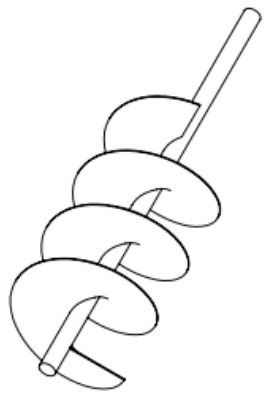
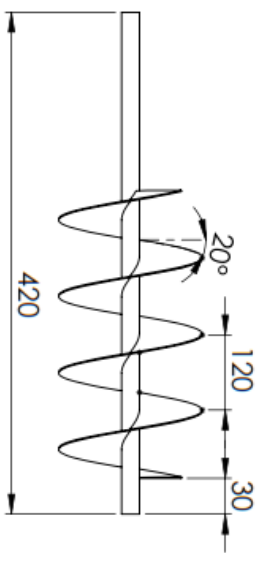
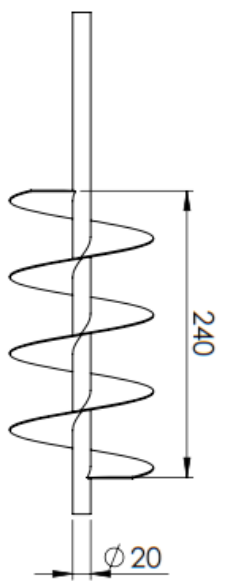

	Skala : 1:5	Nama : Yoyok Yulianto	Peringatan	
	Satuan : mm	NIM : 1421600101		
	Tanggal : 12-05-2020	Pembimbing: Dr./r. Mulyati, M.Sc		
UNIVERSITAS 17 AGUSTUS 1945 SURABAYA		SCREW CONVEYOR KIRI	NO :	B5

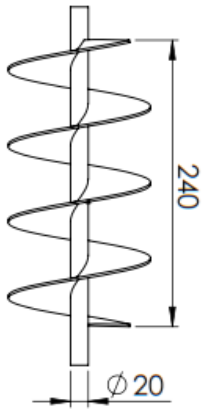

P. Atas

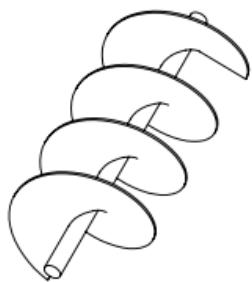

Isometric

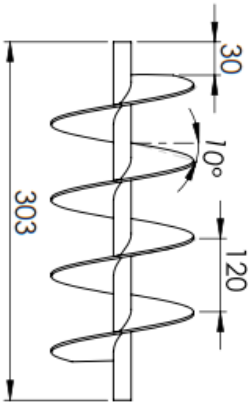

P. Depan

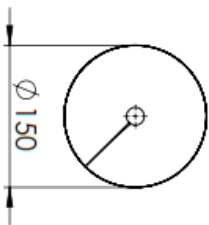

P. Samping

	Skala : 1:5	Nama : Yoyok Yulianto	Peringatan	
	Satuan : mm	Nbi : 1421600101	NO :	B5
Tanggal : 12-05-2020 UNIVERSITAS 17 AGUSTUS 1945 SURABAYA		Pembimbing: Dr.Ir.Mulyin, M.Sc	SCREW CONVEYOR KANAN	

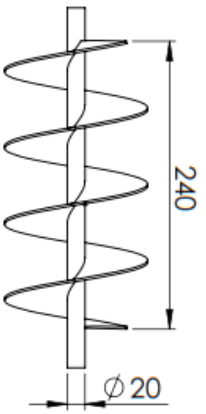

P. Atas



Isometric

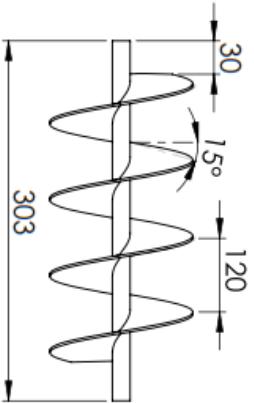

P. Depan

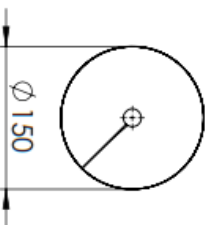

P. Samping

	Skala : 1:5	Nama : Yoyok Yulianto	Peringatan
	Satuan : mm	Nbl : 1421600101	
Tanggal : 12-05-2020		Pembimbing: Dr.Ir.Muhyin, M.sc	
UNIVERSITAS 17 AGUSTUS 1945 SURABAYA		SCREW CONVEYOR KANAN	NO : B5

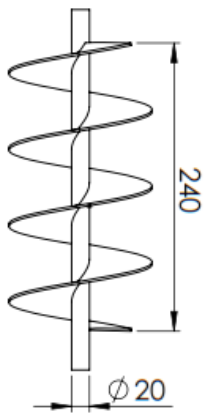

P. Atas



Isometric

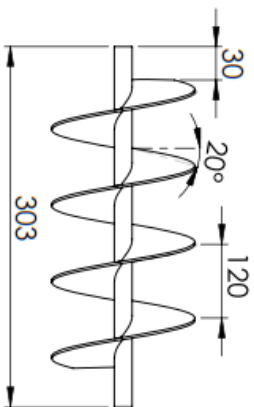

P. Depan

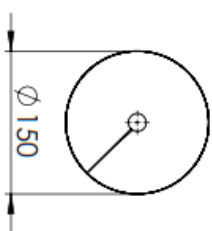

P. Samping

	Skala : 1:5	Nama : Yoyok Yulianto	Peringatan
	Satuan : mm	Nbi : 1421600101	
Tanggal : 12-05-2020 Pembimbing: Dr.Ir.Mulyin, M.Sc		UNIVERSITAS 17 AGUSTUS 1945 SURABAYA	
SCREW CONVEYOR KANAN		NO :	85