

“LAMPIRAN”

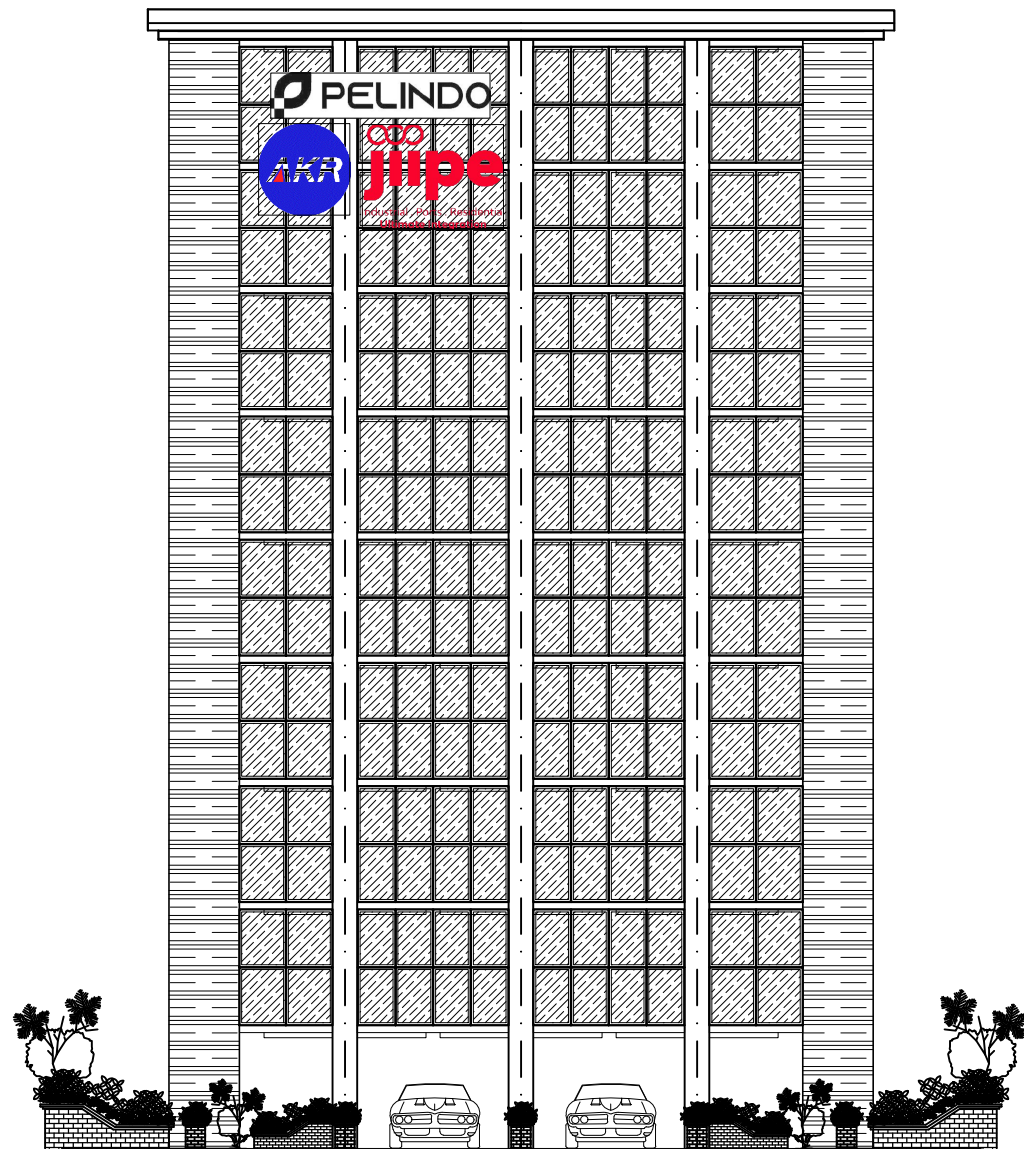

TAMPAK DEPAN
 SKALA 1 : 1



PROGRAM STUDI TEKNIK SIPIL
 FAKULTAS TEKNIK
 UNIVERSITAS 17 AGUSTUS 1945 SURABAYA

JUDUL TUGAS AKHIR

MODIFIKASI PERANCANGAN STRUKTUR
 MENGGUNAKAN FLAT SLAB DAN SHEAR
 WALL PADA PEMBANGUNAN GEDUNG
 KANTOR BKMS JIPE

DOSEN PEMBIMBING

Retno Trimurtiningrum, S.T., M.T.

NAMA MAHASISWA

Rizal Achmed Nurfaidzin
 1431900120

REVISI

NO	KETERANGAN	PARAF	TANGGAL

NAMA GAMBAR

TAMPAK DEPAN

KETERANGAN

SKALA	NO. GAMBAR	JUMLAH GAMBAR
1 : 1	1	6



PROGRAM STUDI TEKNIK SIPIL
FAKULTAS TEKNIK
UNIVERSITAS 17 AGUSTUS 1945 SURABAYA

JUDUL TUGAS AKHIR

MODIFIKASI PERANCANGAN STRUKTUR
MENGUNAKAN FLAT SLAB DAN SHEAR
WALL PADA PEMBANGUNAN GEDUNG
KANTOR BKMS JIPE

DOSEN PEMBIMBING

Retno Trimurtiningrum, S.T., M.T.

NAMA MAHASISWA

Rizal Achmed Nurfaidzin
1431900120

REVISI

NO	KETERANGAN	PARAF	TANGGAL

NAMA GAMBAR

- DENAH LANTAI DASAR
- DETAIL TULANGAN BALOK, KOLOM
- DETAIL LANTANGAN SHEARWALL
- DETAIL TULANGAN TANGGA

KETERANGAN

SKALA NO. GAMBAR JUMBUH GAMBAR

1 : 1	1	3
-------	---	---

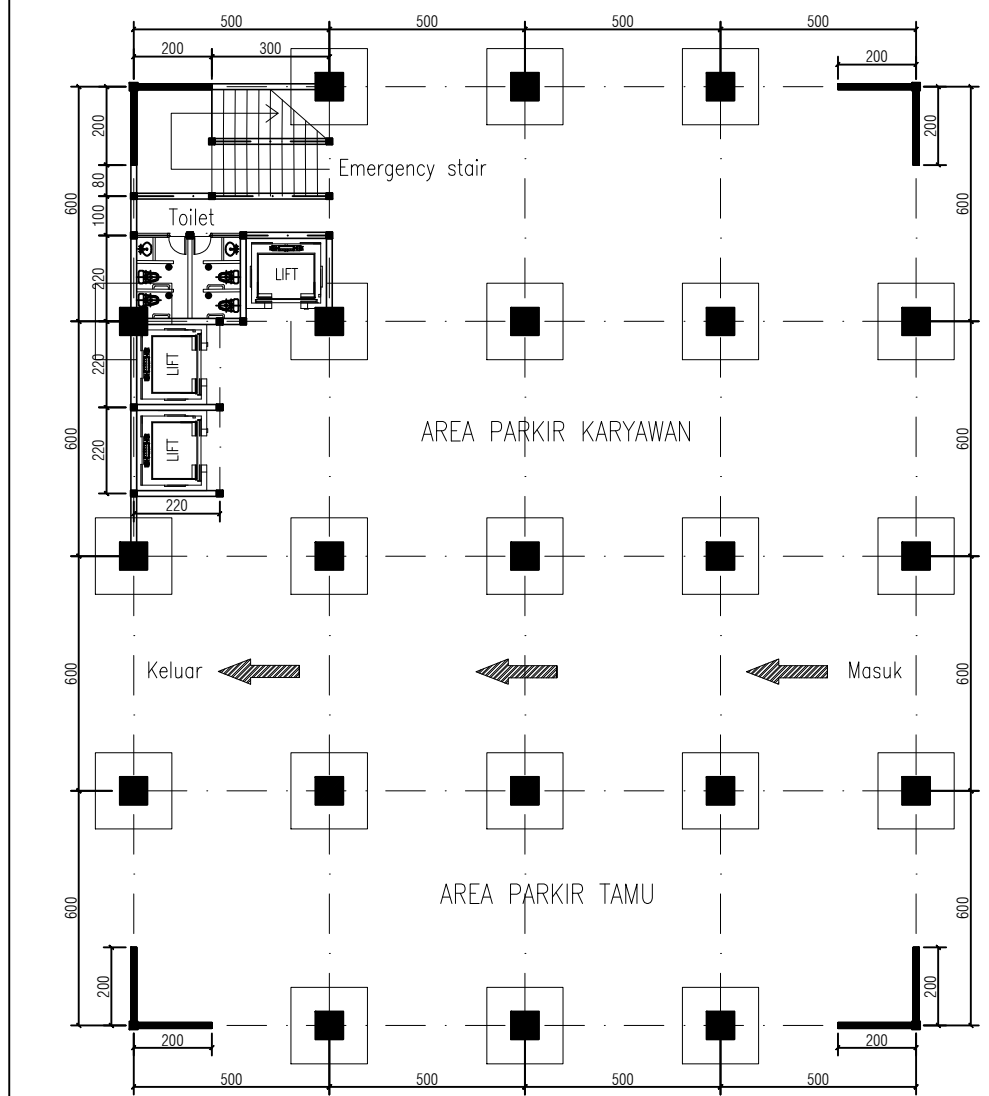

DENAH LANTAI DASAR
SKALA 1 : 1

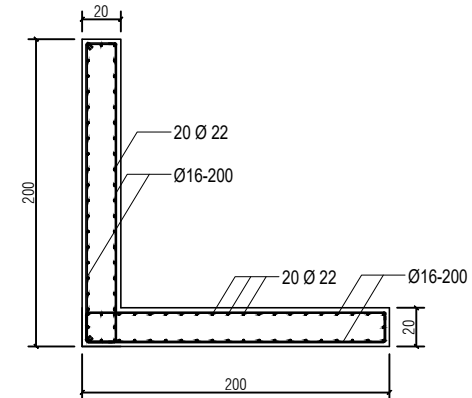
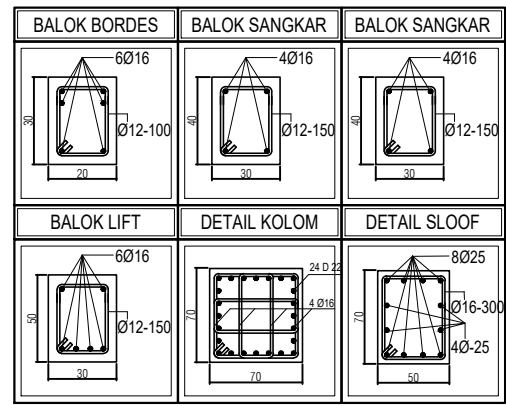

DET. TULANGAN SHEARWALL
SKALA 1 : 1

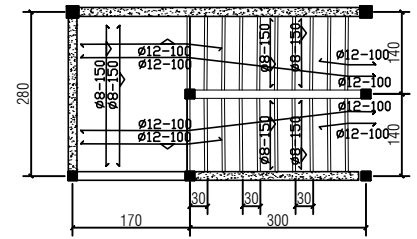

DET. TUL. TANGGA
SKALA 1 : 1

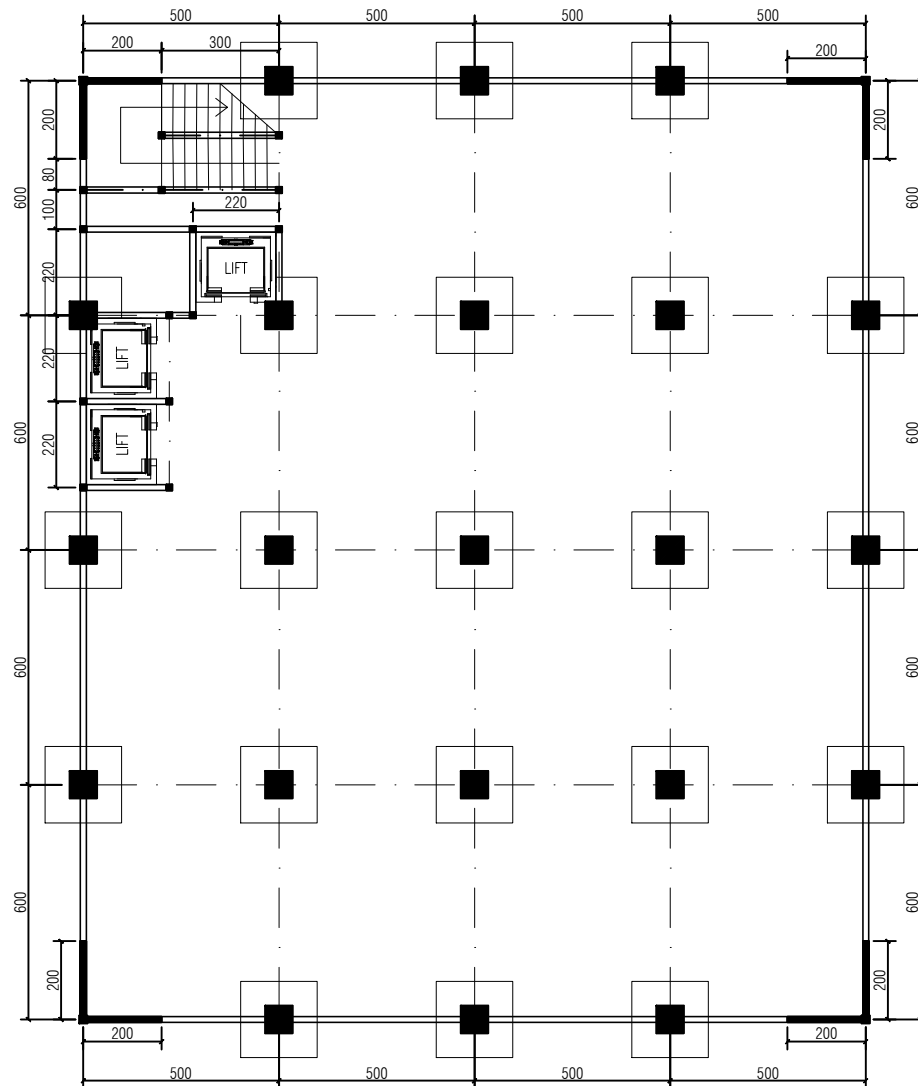

DENAH KOLOM DAN SHEARWALL
SKALA 1 : 1

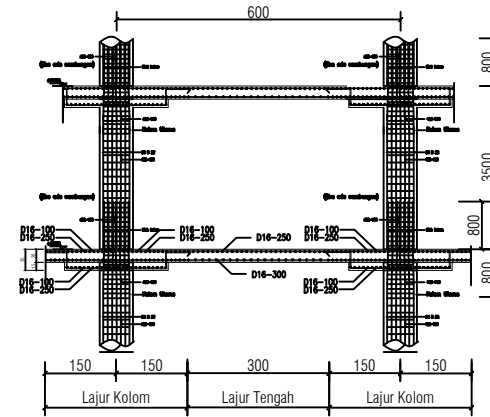

DET. KOLOM DAN FLAT SLAB
SKALA 1 : 1

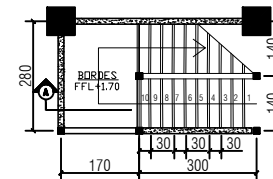

DENAH TANGGA
SKALA 1 : 1

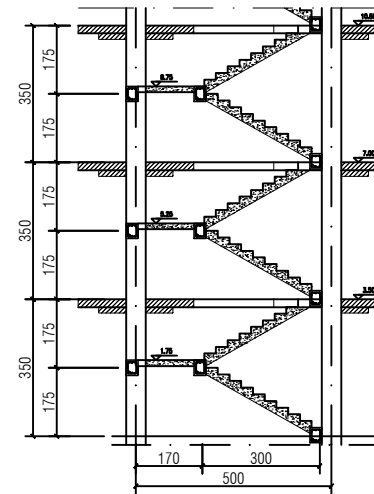

TAMPAK DEPAN TANGGA
SKALA 1 : 1



PROGRAM STUDI TEKNIK SIPIL
FAKULTAS TEKNIK
UNIVERSITAS 17 AGUSTUS 1945 SURABAYA

JUDUL TUGAS AKHIR

MODIFIKASI PERANCANGAN STRUKTUR
MENGGUNAKAN FLAT SLAB DAN SHEAR
WALL PADA PEMBANGUNAN GEDUNG
KANTOR BKMS JIPE

DOSEN PEMBIMBING

Retno Trimurtiningrum, S.T., M.T.

NAMA MAHASISWA

Rizal Achmed Nurfaidzin
1431900120

REVISI

NO	KETERANGAN	PARAF	TANGGAL

NAMA GAMBAR

1. DENAH KOLOM DAN SHEARWALL
2. DETAIL TULANGAN KOLOM
3. DETAIL TULANGAN DROP PANEL
4. DENAH TANGGA
5. POTONGAN TANGGA

KETERANGAN

SKALA	NO. GAMBAR	JUMLAH GAMBAR
1 : 1	1	4



PROGRAM STUDI TEKNIK SIPIL
FAKULTAS TEKNIK
UNIVERSITAS 17 AGUSTUS 1945 SURABAYA

JUDUL TUGAS AKHIR

MODIFIKASI PERANCANGAN STRUKTUR
MENGUNAKAN FLAT SLAB DAN SHEAR
WALL PADA PEMBANGUNAN GEDUNG
KANTOR BKMS JIPE

DOSEN PEMBIMBING

Retno Trimurtiningrum, S.T., M.T.

NAMA MAHASISWA

Rizal Achmed Nurfaidzin
1431900120

REVISI

NO	KETERANGAN	PARAF	TANGGAL

NAMA GAMBAR

1. DETAIL PENULANGAN FLAT SLAB
2. DETAIL TULANGAN FLAT SLAB
3. DETAIL TULANGAN FLAT SLAB

KETERANGAN

SKALA NO. GAMBAR JUMBUH GAMBAR

1 : 1 1 5

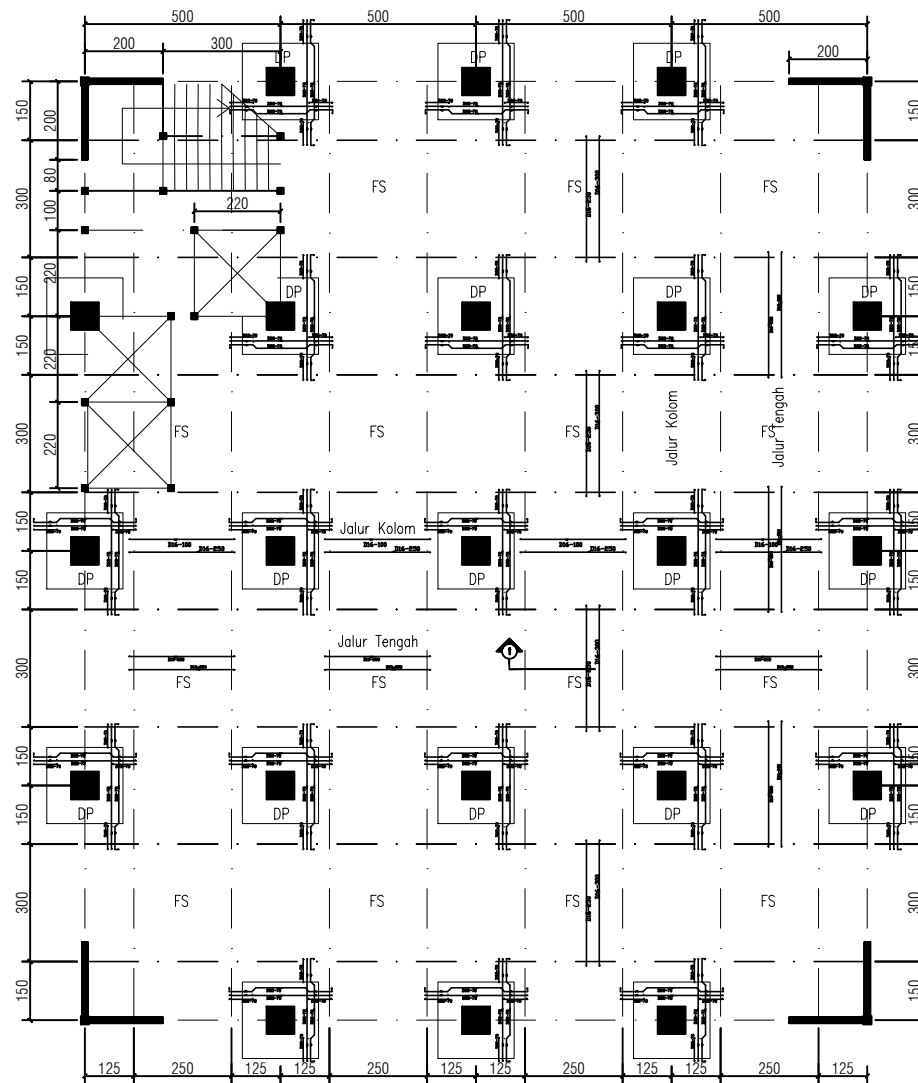

DETAIL PENULANGAN FLAT SLAB
SKALA 1 : 1

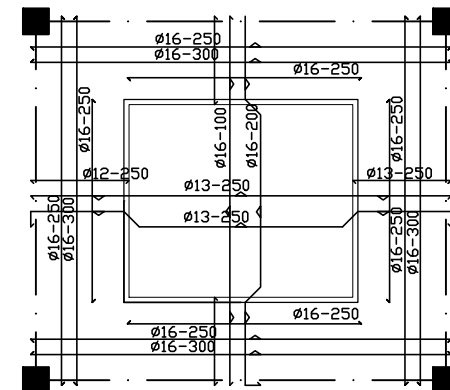

DET. TUL. FLAT SLAB
SKALA 1 : 1

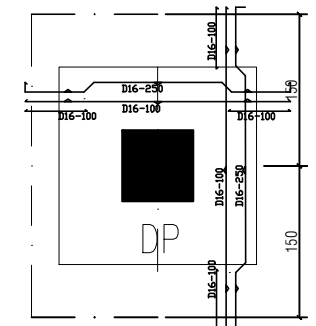

DET. TUL. DROP PANEL DAN FLAT SLAB
SKALA 1 : 1

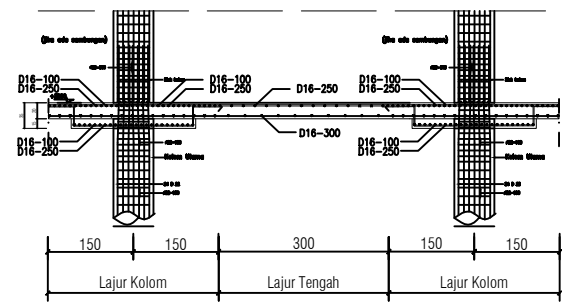

POTONAGAN FLAT SLAB DAN DROP PANEL
SKALA 1 : 1

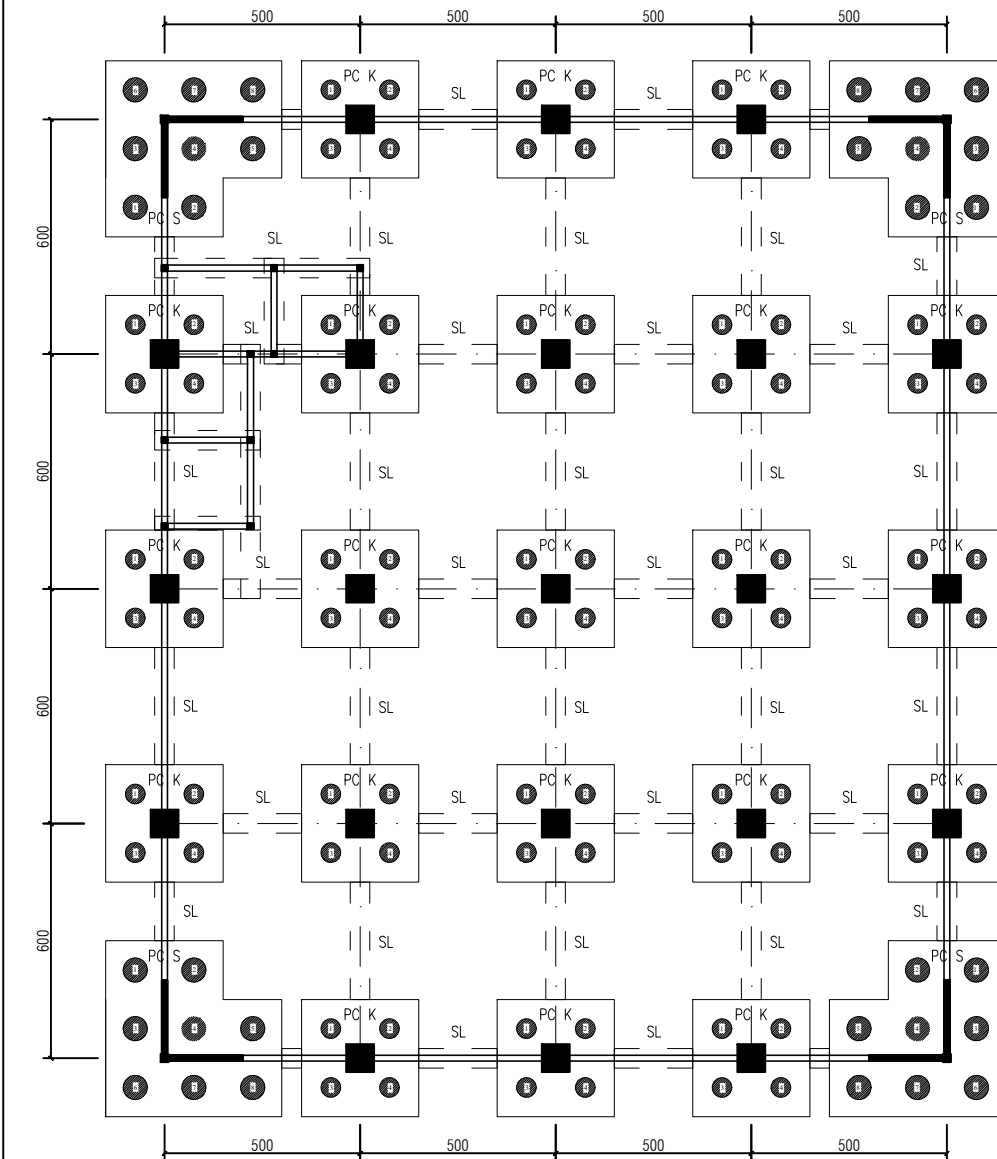

DENAH PONDASI
SKALA 1 : 1

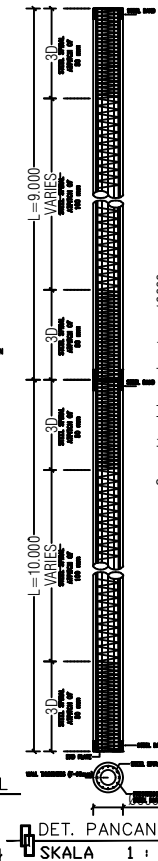
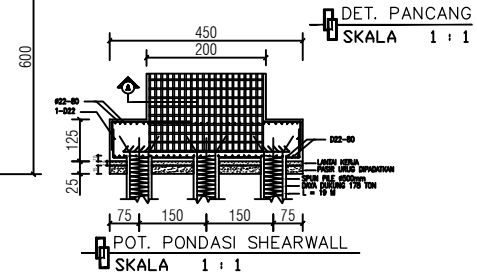
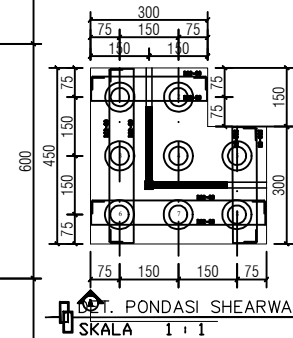
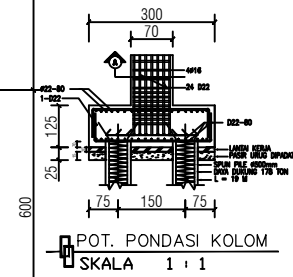

PROGRAM STUDI TEKNIK SIPIL
FAKULTAS TEKNIK
UNIVERSITAS 17 AGUSTUS 1945 SURABAYA

JUDUL TUGAS AKHIR

MODIFIKASI PERANCANGAN STRUKTUR
MENGUNAKAN FLAT SLAB DAN SHEAR
WALL PADA PEMBANGUNAN GEDUNG
KANTOR BKMS JIPE

DOSEN PEMBIMBING

Retno Trimurtiningrum, S.T., M.T.

NAMA MAHASISWA

Rizal Achmed Nurfaidzin
1431900120

REVISI

NO	KETERANGAN	PARAF	TANGGAL

NAMA GAMBAR

1. DENAH PONDASI
2. DETAIL PONDASI KOLOM
3. DETAIL PONDASI SHEARWALL
4. DETAIL TIANG PANCANG

KETERANGAN

SKALA	NO. GAMBAR	JUMLAH GAMBAR
1 : 1	1	6

ORIGINALITY REPORT

18%

SIMILARITY INDEX

18%

INTERNET SOURCES

2%

PUBLICATIONS

7%

STUDENT PAPERS

PRIMARY SOURCES

1	repository.its.ac.id Internet Source	7%
2	repository.untag-sby.ac.id Internet Source	1%
3	eprints.umm.ac.id Internet Source	1%
4	repository.ummat.ac.id Internet Source	1%
5	Submitted to Universitas 17 Agustus 1945 Surabaya Student Paper	1%
6	ejournal.unsrat.ac.id Internet Source	1%
7	Submitted to Universitas Bung Hatta Student Paper	1%
8	repository.unj.ac.id Internet Source	<1%
9	123dok.com Internet Source	<1%
10	pdfcoffee.com Internet Source	<1%

11	Submitted to Sriwijaya University Student Paper	<1 %
12	repository.uhn.ac.id Internet Source	<1 %
13	eprints.itn.ac.id Internet Source	<1 %
14	www.scribd.com Internet Source	<1 %
15	e-journal.uajy.ac.id Internet Source	<1 %
16	Submitted to Clarkston Community Schools Student Paper	<1 %
17	adoc.pub Internet Source	<1 %
18	ojs.unik-kediri.ac.id Internet Source	<1 %
19	Submitted to Universitas Pancasila Student Paper	<1 %
20	hdl.handle.net Internet Source	<1 %
21	idoc.pub Internet Source	<1 %
22	dspace.uii.ac.id Internet Source	<1 %
23	Submitted to Yonkers High School Student Paper	

<1 %

24

Submitted to North South University

Student Paper

<1 %

25

journal.unpar.ac.id

Internet Source

<1 %

26

jurnal.usu.ac.id

Internet Source

<1 %

27

Submitted to Universidad Cesar Vallejo

Student Paper

<1 %

28

docplayer.info

Internet Source

<1 %

29

Submitted to Politeknik Negeri Bandung

Student Paper

<1 %

30

Submitted to Fakultas Ekonomi dan Bisnis
Universitas Gadjah Mada

Student Paper

<1 %

31

Submitted to Universitas International
Batam

Student Paper

<1 %

32

jagobangunan.com

Internet Source

<1 %

33

Submitted to Universitas Islam Malang

Student Paper

<1 %

34

www.argentina.gob.ar

Internet Source

<1 %

35	M. Basyir, F. Amir, S. Maricar, I.G.M. Oka. "Perancangan Struktur Rangka Pemikul Momen Khusus (SRPMK) Ruko 4 Lantai Berdasarkan SNI 2847-2019 dan SNI 1726-2019", REKONSTRUKSI TADULAKO: Civil Engineering Journal on Research and Development, 2022 Publication	<1 %
36	core.ac.uk Internet Source	<1 %
37	repository.utp.ac.id Internet Source	<1 %
38	Submitted to Institut Teknologi Nasional Malang Student Paper	<1 %
39	text-id.123dok.com Internet Source	<1 %
40	repository.usm.ac.id Internet Source	<1 %
41	herbycalvinpascal.files.wordpress.com Internet Source	<1 %
42	jurnal.ft.umi.ac.id Internet Source	<1 %
43	repository.unibos.ac.id Internet Source	<1 %
44	Submitted to Technological Institute of the Philippines Student Paper	<1 %

45	Hernandez Cruz Rosa Maria. "Centro academico de artes plasticas", TESIUNAM, 2005 Publication	<1 %
46	ejournal.undip.ac.id Internet Source	<1 %
47	repositori.uma.ac.id Internet Source	<1 %
48	wahyudhaekaprat.blogspot.com Internet Source	<1 %
49	www.millirefleks.com Internet Source	<1 %
50	adoc.tips Internet Source	<1 %
51	eprints.ums.ac.id Internet Source	<1 %
52	es.scribd.com Internet Source	<1 %
53	jurnal.umj.ac.id Internet Source	<1 %
54	ml.scribd.com Internet Source	<1 %
55	repository.unej.ac.id Internet Source	<1 %
56	Submitted to Binus University International Student Paper	<1 %

57 Navin Chandra. "Stability of L4 for radiated rigid primaries in resonant cases", Planetary and Space Science, 2004
Publication <1 %

58 passed-not-narcotics.icu
Internet Source <1 %

59 pt.scribd.com
Internet Source <1 %

60 www.ejournal.warmadewa.ac.id
Internet Source <1 %

61 P. Di Francesco. "Rectangular matrix models and combinatorics of colored graphs", Nuclear Physics B, 2003
Publication <1 %

62 ejurnal.its.ac.id
Internet Source <1 %

63 ocw.upj.ac.id
Internet Source <1 %

Exclude quotes Off

Exclude matches Off

Exclude bibliography On